

iHome Voice

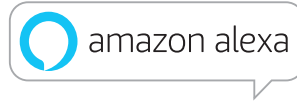

**Model iAV14**  
**Bluetooth Bedside/Home Office Stereo Speaker**  
**System with Far Field Voice**

QUESTIONS? visit [www.ihome.com](http://www.ihome.com)

Contact Us: 1•800•288•2792

# WELCOME

Thank you for choosing the iAV14 Stereo Speaker from iHome.

## GETTING STARTED

This unit ships with the following items. Please check to see that all items are present.

1. iAV14 stereo speaker
2. Universal AC power adapter



1. iAV14 speaker

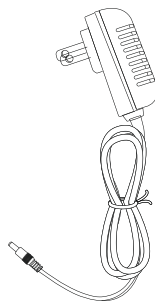

2. AC adapter

# FEATURES & FUNCTIONS

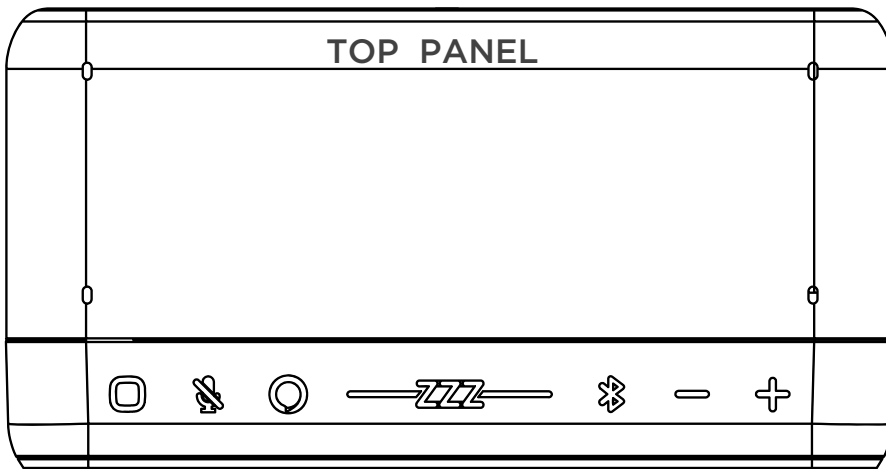

## Smart Button

Configure your smart button preferences in the iHome AVS app. If the Smart Button is not configured, press to Play/Pause audio.

## Mute Button

Press to mute microphone. The Alexa Light Bar will turn red to indicate that Alexa is not listening.

## Alexa Button

The iAV14 features far field voice recognition. Alexa can also be triggered by tapping the Alexa Button.

## Snooze/Display Dimmer Button

Press to cycle through four display dimmer settings: High, 3, 2, 1, and OFF. When alarm sounds, press to Snooze.

## Bluetooth Button

Press to enter Bluetooth mode. *Press and hold 3* for seconds to pair devices. Press to answer a call, or press and hold to end Bluetooth call.

## Volume Buttons

Press to adjust volume levels up or down.

# FEATURES & FUNCTIONS

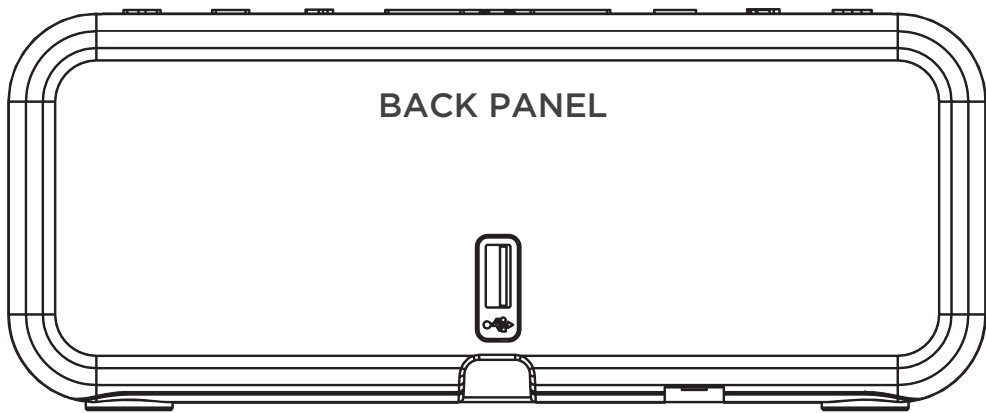
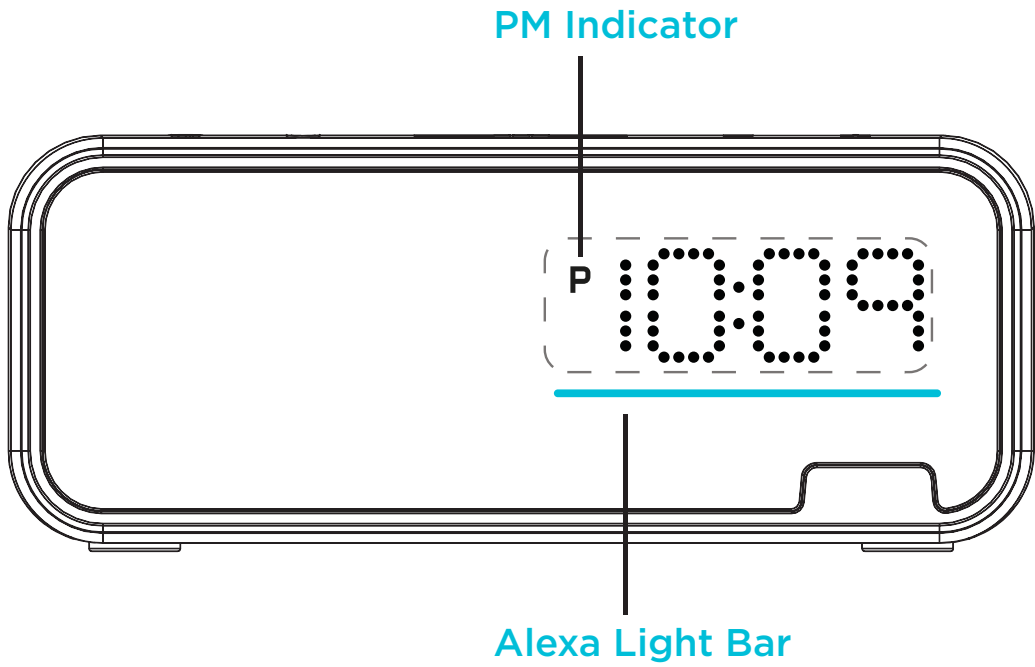

## USB Port

While unit is connected to AC power, connect USB cable to charge devices.

# CONNECTING THE IAV14

Plug the included AC adapter into the DC jack on the bottom of the unit and connect the plug to a working outlet not controlled by a light switch. Use only the adapter supplied in the box.

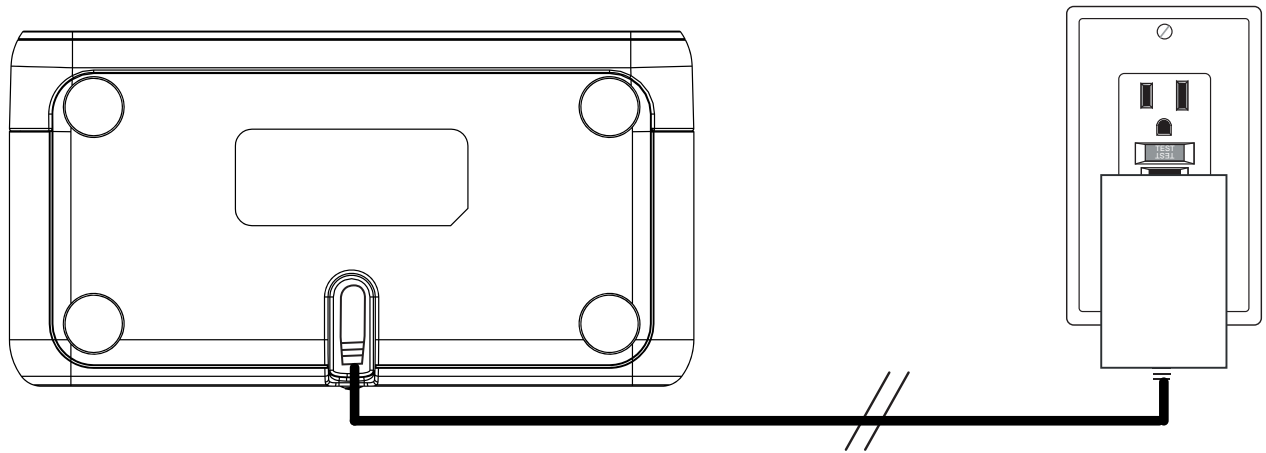

## **Wi-Fi Connection Tip:**

Some routers may feature Protected Management Frames. Disable this feature if your router has it enabled.

# BLUETOOTH MODE

## PAIRING

Pairing establishes a unique communication connection between the unit and your Bluetooth device. Once paired, you will be able to stream audio wirelessly to the iAV14.

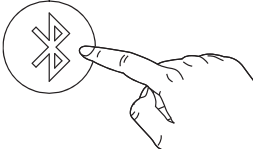

1. Turn on your Bluetooth device and make it “discoverable” by turning on Bluetooth mode (check in Options or Settings).
2. Press the **Bluetooth Button**  to enter Bluetooth mode. Press and hold to enter pairing mode. You will hear a voice prompt as the unit attempts to pair with your device. “iHome iAV14” should appear on your device’s menu. Select “iHome iAV14” on your device to begin/complete pairing. If your device asks for a password, enter 1234 on the keyboard of your device. You will hear a voice prompt once your device is connected.

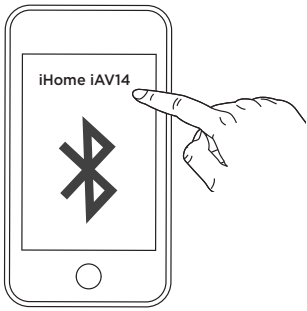

\* If no device is paired within 3 minutes, the unit will revert to its previous state.

\* The unit will automatically link with the previously paired device as long as that device is still within range (about 33 feet).

\* To clear/reset Bluetooth, press and hold the Bluetooth button for 10 seconds until you hear a long beep.

# BLUETOOTH MODE

## PLAYING AUDIO VIA BLUETOOTH

1. You can manually play music by using the controls on your Bluetooth-enabled smartphone.
2. Press and release the **-** or **+** **Volume Buttons** on the iAV14 to adjust speaker volume. You can also adjust the output volume on your Bluetooth device.

## USING THE SPEAKERPHONE

Unit must be paired with a Bluetooth-enabled phone to use the speakerphone feature. When a call is received, current audio is paused.

- \* Press and release the Bluetooth Button  to answer an incoming call.
- \* *Press and hold* to ignore or end a call.

# SETTING UP THE APPS



1. Download the  **iHome AVS** app and the Amazon Alexa app from the App Store or Google Play.



2. Follow app instructions in the AVS app for account setup and to establish your speaker's Wi-Fi connection.
3. Connect your Amazon account to enjoy the Alexa voice capability of your iAV14.



Explore the app to:

-  **Configure** Smart Button
-  **Stream** audio (iHeartRadio, Spotify, and more)
-  **Update** to the latest firmware



# ALARMS

You can use voice commands to ask Alexa to set an alarm to your desired wake-up time. The alarm icon  will appear on the iAV14 display to confirm that your alarm is set.

## ADJUSTING ALARMS

There are two ways to adjust your alarm settings:

- \* Using Alexa voice commands
- \* Using the Alexa app

## ALARM TYPES

### ALEXA TONE ALARMS

**Note:** If you set an alarm without specifying the type (for example, waking to a Spotify playlist), the unit will automatically set a tone alarm.

To set a tone alarm:

- \* Ask Alexa to set an alarm to your desired wake-up time.

### STOPPING TONE ALARMS / SNOOZING

- \* When the alarm sounds, press the Alexa Button on the iAV14 or say 'Alexa, stop' to disable the tone alarm.
- \* Press the Snooze Button on the iAV14 or say 'Alexa, snooze' to snooze a sounding tone alarm.

# ALARM TYPES (CONTINUED)

## ALEXA MUSIC ALARMS

- \* Ask Alexa to set an alarm to your desired wake-up time and music streaming service.

For example, say:

*'Alexa, set an alarm for 7:00AM to wake to iHeart Radio.'*

*'Alexa, set an alarm for 10AM to wake to my Spotify playlist.'*

## STOPPING MUSIC ALARMS / SNOOZING

- \* Say 'Alexa, stop' to disable a sounding alarm.
- \* Say 'Alexa, snooze' to snooze a sounding alarm.

## IHOME AVS APP: SET ALARM VOLUME

Use your  iHome AVS app to adjust your maximum alarm volume level. Under the Settings section of the App, go to Alarms:

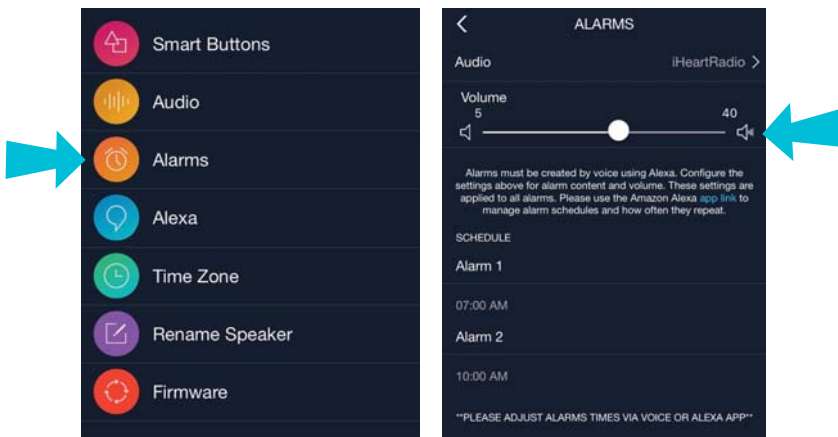

**Note:** Make sure to set the your correct time zone in both the Alexa app and the iHome AVS app to ensure an accurate wake time.

# ALEXA LIGHT BAR

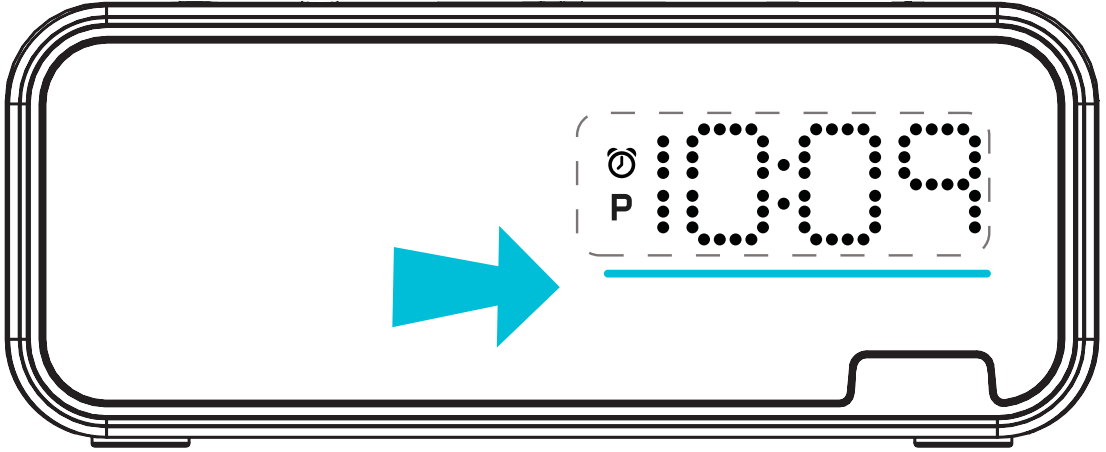

The built-in Alexa Light Bar uses visual cues to indicate the various attention states of the unit while connected to the  iHome AVS app.

Listening

Flashing



End Listening



Thinking

Flashing



Responding

Blinking



Mic Muted



Error

Blinking



Notification

Blinking



# FIRMWARE UPDATES

Periodically, iHome will send firmware updates 'over the air' that will automatically install new features and services to the iAV14. This process occurs via Wi-Fi and usually takes 3-10 minutes depending on connection speed and file size.

You will hear a voice prompt from the iAV14 when a firmware update begins. The Alexa Light Bar will flash red and blue while the update is in progress, and the unit will automatically reboot once the update is complete.

**DO NOT UNPLUG THE UNIT DURING A FIRMWARE UPDATE. DOING SO MAY DAMAGE THE UNIT.**

# MAINTENANCE

- Place the unit on a level surface away from sources of direct sunlight or excessive heat.
- Protect your furniture when placing your unit on a natural wood and lacquered finish. A cloth or other protective material should be placed between it and the furniture.
- Clean your unit with a soft cloth moistened only with mild soap and water. Stronger cleaning agents such as thinner or similar materials can damage the surface of the unit.

# TROUBLESHOOTING

<b>SYMPTOM</b>	<b>POSSIBLE REASON</b>	<b>SOLUTION</b>
Unit won't turn on	AC adapter isn't plugged into a working wall socket or not properly connected	Plug the AC adapter into a working wall socket and plug the AC cable into the DC jack on the unit. Make sure any associated wall switch that controls the outlet is ON.
Device does not respond to the unit and/or device is playing but no sound comes out/ unit doesn't respond	Unit is not properly connected to power source and/or device is paused	Try adjusting volume on unit and audio device. Make sure unit is properly paired to your device (check that iHome iAV14 appears in the Bluetooth menu).
Erratic performance	External interference	Move unit away from potential sources of external interference such as computers, modems, wireless devices (routers) or fluorescent light.
No sound	Volume is too low	Turn volume up on unit and/or your device
	Volume is too high	Turn volume down on unit and your device
Sound distorted	Sound source is distorted	If the original sound file (MP3) is old or of poor quality, distortion and noise are easily noticed with high-power speakers. Try upgrading file from a trusted source such as iTunes.
Poor Alexa response	Unit located too far from router	Move the unit closer to your router

# FCC INFORMATION

iAV14

FCC ID:EMOiAV14  
IC:986B-iAV14

## FCC Radiation Exposure Statement

This equipment complies with FCC RF radiation exposure limits set forth for an uncontrolled environment.

**This device complies with Part 15 of the FCC Rules, operation is subject to the following two conditions: (1) This device may not cause harmful interference, and (2) this device must accept any interference received, including interference that may cause undesired operation.**

- Warning: Changes or modifications to this unit not expressly approved by the party responsible for compliance could void the user's authority to operate the equipment.
- NOTE: This equipment has been tested and found to comply with the limits for a Class B digital device, pursuant to Part 15 of the FCC Rules.

These limits are designed to provide reasonable protection against harmful interference in a residential installation. This equipment generates, uses and can radiate radio frequency energy and, if not installed and used in accordance with the instructions, may cause harmful interference to radio communications.

However, there is no guarantee that interference will not occur in a particular installation. If this equipment does cause harmful interference to radio or television reception, which can be determined by turning the equipment off and on, the user is encouraged to try to correct the interference by one or more of the following measures:

- Reorient or relocate the receiving antenna.
- Increase the separation between the equipment and receiver.
- Connect the equipment into an outlet on a circuit different from that to which the receiver is connected.
- Consult the dealer or an experienced radio/TV technician for help.

CAN ICES-3 (B)/NMB-3(B)

## Canada Statement

This device complies with Industry Canada's license-exempt RSSs. Operation is subject to the following two conditions:

- (1) This device may not cause interference; and
- (2) This device must accept any interference, including interference that may cause undesired operation of the device.

Le présent appareil est conforme aux CNR d'Industrie Canada applicables aux appareils radio exempts de licence. L'exploitation est autorisée aux deux conditions suivantes :

- (1) l'appareil ne doit pas produire de brouillage;
- (2) l'utilisateur de l'appareil doit accepter tout brouillage radioélectrique subi, même si le brouillage est susceptible d'en compromettre le fonctionnement.

The device meets the exemption from the routine evaluation limits in section 2.5 of RSS 102 and compliance with RSS-102 RF exposure, users can obtain Canadian information on RF exposure and compliance.

Le dispositif rencontre l'exemption des limites courantes d'évaluation dans la section 2.5 de RSS 102 et la conformité à l'exposition de RSS-102 rf, utilisateurs peut obtenir l'information canadienne sur l'exposition et la conformité de rf.

# IMPORTANT SAFETY TIPS

When used in the directed manner, this unit has been designed and manufactured to ensure your personal safety. However, improper use can result in potential electrical shock or fire hazards. Please read all safety and operating instructions carefully before installation and use, and keep these instructions handy for future reference. Take special note of all warnings listed in these instructions and on the unit.

1. Water and Moisture – The unit should not be used near water. For example: near a bathtub, washbowl, kitchen sink, laundry tub, swimming pool or in a wet basement.
2. Ventilation – The unit should be situated so that its location or position does not interfere with its proper ventilation. For example, it should not be situated on a bed, sofa, rug or similar surface that may block ventilation openings. Also, it should not be placed in a built-in installation, such as a bookcase or cabinet, which may impede the flow of air through the ventilation openings.
3. Heat – The unit should be situated away from heat sources such as radiators, heat registers, stoves or other appliances (including amplifiers) that produce heat.
4. Power Sources – The unit should be connected to a power supply only of the type described in the operating instructions or as marked on the appliance. Only use the AC adapter that came with the unit.
5. Power-Cable Protection – Power supply cables should be routed so that they are not likely to be walked on or pinched by items placed upon or against them. It is always best to have a clear area from where the cable exits the unit to where it is plugged into an AC socket.
6. Cleaning – The unit should be cleaned only as recommended. See the Maintenance section of this manual for cleaning instructions.
7. Objects and Liquid Entry – Care should be taken so that objects do not fall and liquids are not spilled into any openings or vents located on the product.
8. Attachments – Do not use attachments not recommended by the product manufacturer.
9. Lightning and Power Surge Protection – Unplug the unit from the wall socket and disconnect the antenna or cable system during a lightning storm or when it is left unattended and unused for long periods of time. This will prevent damage to the product due to lightning and power-line surges.
10. Overloading – Do not overload wall sockets, extension cords, or integral convenience receptacles as this can result in a risk of fire or electric shock.
11. Damage Requiring Service – The unit should be serviced by qualified service personnel when:
  - A. the power supply cable or plug has been damaged.
  - B. objects have fallen into or liquid has been spilled into the enclosure.
  - C. the unit has been exposed to rain.
  - D. the unit has been dropped or the enclosure damaged.
  - E. the unit exhibits a marked change in performance or does not operate normally.
12. Periods of Non-use – If the unit is to be left unused for an extended period of time, such as a month or longer, charge the unit fully before storage
13. Servicing – The user should not attempt to service the unit beyond those methods described in the user's operating instructions. Service methods not covered in the operating instructions should be referred to qualified service personnel.
14. Magnetic Interference: This product's speakers contain powerful magnets which could cause interference or damage to sensitive equipment such as hard drives, CRT televisions and monitors, as well as medical, scientific, and navigational devices. Keep this unit away from these products at all times.