

# iHome®



## iBN10

### ***Bluetooth Wireless Stereo Speaker System***

with Speakerphone and USB Charging



Questions? Contact Customer Service at 1-800-288-2792

instruction manual



## Introduction

Thank you for purchasing the iHome iBN10. This product is designed to provide high quality wireless sound from your iPad, iPhone, iPod, computer, or other Bluetooth audio device.

Along with the included Quick Bluetooth Connection Guide this instruction booklet explains the basic operation and care of the unit. Please read them carefully and keep for future reference.

This unit features NFC (Near Field Communication) technology which allows you to wirelessly connect your NFC-enabled device to instantly 'pair and play'. See your device's user manual for details on how to interact with NFC devices. If your Bluetooth device does not support NFC, you can pair it manually with this unit.

## Maintenance

- Place the unit on a level surface away from sources of direct sunlight or excessive heat.
- Protect your furniture when placing your unit on a natural wood and lacquered finish. A cloth or other protective material should be placed between it and the furniture.
- Clean your unit with a soft cloth moistened only with mild soap and water. Stronger cleaning agents, such as thinner or similar materials can damage the surface of the unit.

# FCC/IC Information

# iBN10

FCC ID:EMOiBN10

IC:986B-iBN10

## FCC Radiation Exposure Statement

This equipment complies with FCC RF radiation exposure limits set forth for an uncontrolled environment. This transmitter must not be co-located or operating in conjunction with any other antenna or transmitter.

This device complies with Industry Canada licence-exempt RSS standard(s). Operation is subject to the following two conditions:

- (1) This device may not cause interference, and
- (2) This device must accept any interference, including interference that may cause undesired operation of the device.

This device complies with Part 15 of the FCC Rules, operation is subject to the following two conditions:

- (1) This device may not cause harmful interference, and
- (2) this device must accept any interference received, including interference that may cause undesired operation.

- Warning: Changes or modifications to this unit not expressly approved by the party responsible for compliance could void the user's authority to operate the equipment.
- NOTE: This equipment has been tested and found to comply with the limits for a Class B digital device, pursuant to Part 15 of the FCC Rules.

These limits are designed to provide reasonable protection against harmful interference in a residential installation. This equipment generates, uses and can radiate radio frequency energy and, if not installed and used in accordance with the instructions, may cause harmful interference to radio communications.

However, there is no guarantee that interference will not occur in a particular installation. If this equipment does cause harmful interference to radio or television reception, which can be determined by turning the equipment off and on, the user is encouraged to try to correct the interference by one or more of the following measures:

- Reorient or relocate the receiving antenna.
- Increase the separation between the equipment and receiver.
- Connect the equipment into an outlet on a circuit different from that to which the receiver is connected.
- Consult the dealer or an experienced radio/TV technician for help.

CAN ICES-3 (B)/NMB-3(B)

The device meets the exemption from the routine evaluation limits in section 2.5 of RSS 102 and compliance with RSS-102 RF exposure, users can obtain Canadian information on RF exposure and compliance.

QDID:B020415

# Table of Contents

# iBN10

Included / Meet Your iBN10 .....	1-3
Setting Up the Unit / Turning the Unit ON and OFF .....	4
Setting the Clock / FM Radio .....	5
Setting and Using FM Presets / Using FM Radio in Other Countries.....	6
Using Bluetooth: Pairing Your Device Using NFC .....	7
Using Bluetooth: Pairing Your Device using Bluetooth .....	8
Playing Audio Via Bluetooth.....	9
Using the Speakerphone feature.....	10
Playing Audio Via Aux line-in .....	10
Charging Devices Via USB Port / Dimming the Display .....	11
Replacing and Installing Clock Backup Batteries .....	12
Consumer Product Safety Guide .....	13-14
Troubleshooting .....	15
Warranty .....	16

# iBN10

## Included

- iBN10 System
- 100V-240V universal AC adaptor
- Audio cable

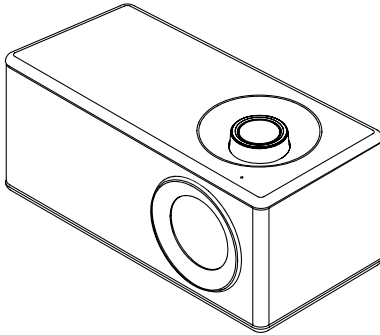

iBN10



AC adaptor



Audio cable

# Meet Your iBN10

# iBN10

## Top

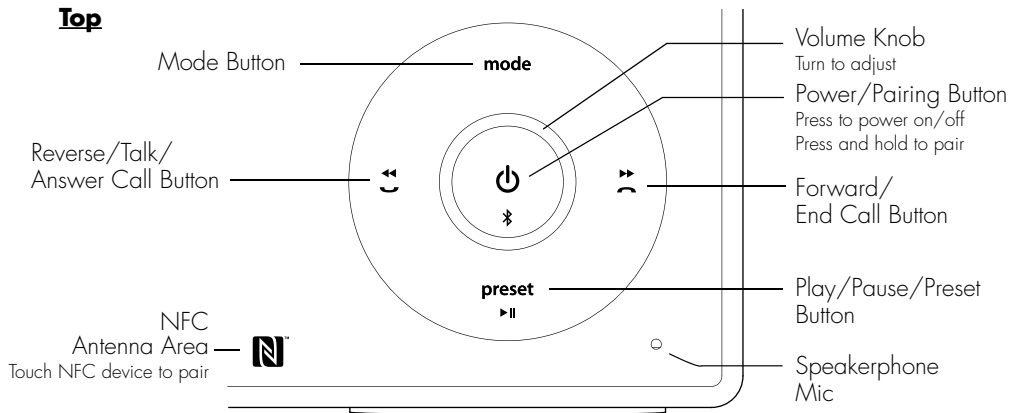

## Back

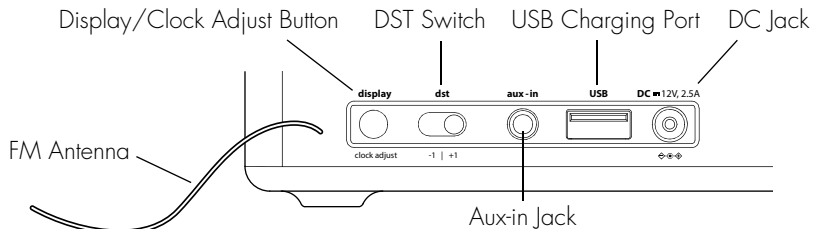

## The Display

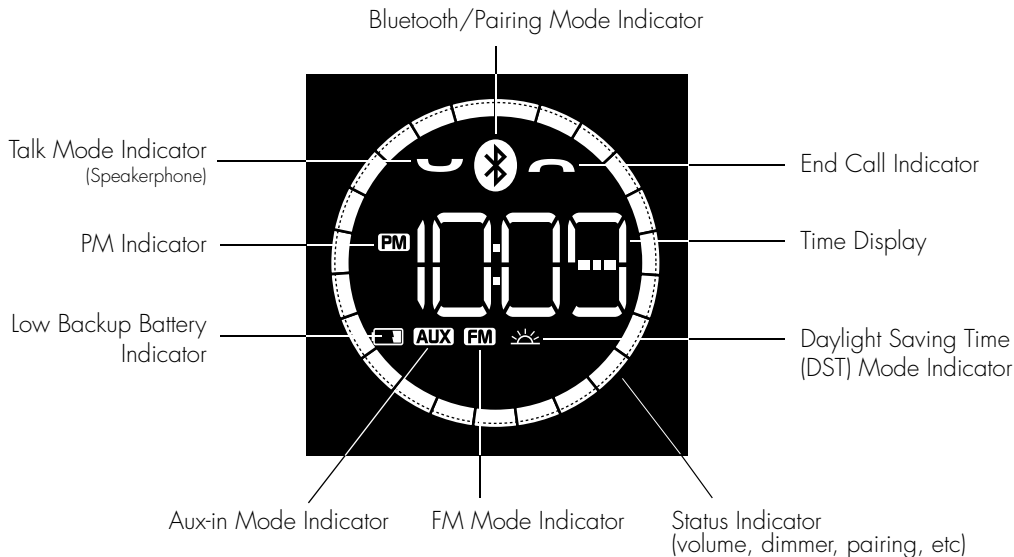

When unit is off *press and hold* the Display/Clock Button on the back of the unit for 5 seconds to adjust the clock display from High to Low.

## Setting Up the Unit

Connect the included AC adaptor to the DC jack located on the back panel of the unit and connect the other end to a working wall outlet. Extend the FM antenna fully for best reception.

## Turning the Unit ON and OFF

1. Once the AC adaptor is properly connected, press the **Power/Pairing Button** located on top of the unit to turn the unit ON. The power indicators on the front panel display and the **Power/Pairing Button** will light.
2. Press the **Power/Pairing Button** to turn the unit OFF.

## Using the iBN10

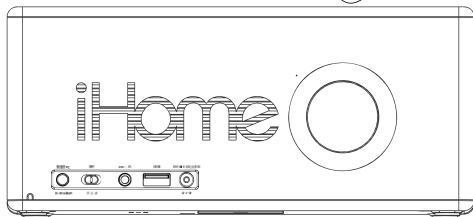
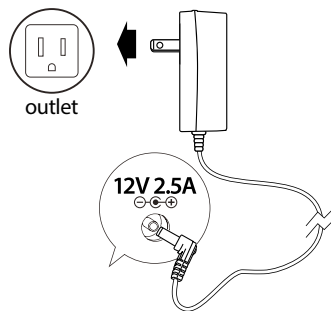



## Setting the Clock

# Using the iBN10

The unit features a Daylight Saving Time (DST) Switch on the back of the unit to quickly add or subtract an hour to account for Daylight Saving Time and Standard Time differences. *Before setting the time*, move the **DST Switch** to **+1** to add an hour or to **-1** to subtract an hour.

1. Press the **Display/Clock Adjust Button** located on the back of the unit. The clock display flashes and a beep sounds, indicating clock setting mode.
2. Press the **◀** or **▶** **Buttons** to adjust the clock to the current time (hold for rapid setting). Make sure you set the correct AM/PM time. The PM indicator appears to the left of the display.
3. To toggle the clock display between standard 12 hour time and 24 hour ("military") time display, press the **Mode Button** during time setting while time digits are flashing.
4. Press the **Display/Clock Adjust Button** to confirm the time and exit clock setting mode. 2 beeps will confirm clock setting is complete.

## FM Radio

Extend the FM antenna for best reception.

1. Press the **⏻ Button** on the unit to turn it on.
2. Press and release the **Mode Button** as needed until the FM indicator icon and current FM radio frequency appear on the display.
3. Press the **◀** or **▶** **Buttons** to tune the radio to the desired station (hold to scan for the next clear station).
4. Turn the **Volume Knob** to adjust the volume on the unit.
5. When you are through listening, press the **⏻ Button** to turn the unit off.

## Setting and Using FM Presets

# Using the iBN10

The unit allows you to store up to 6 FM radio station presets

1. Press the **Power Button** on the unit to turn it on.
2. Press and release the **Mode Button** as needed until the FM indicator icon and current FM radio frequency appear on the display.
3. Press and release the **►|| Presets Button** as needed until the preset number (P1- P6) you wish to set is displayed, then *press and hold* the **►|| Presets Button** to enter setting mode.
4. Press the **◀◀** or **▶▶** **Buttons** to tune the radio to the desired station (hold to scan for the next clear station).
5. Press and release the **►|| Presets Button** to confirm. 2 beeps will sound to confirm the preset has been assigned. Continue steps 3 - 5 until you have set up to 6 preset stations.
6. To listen to a preset FM station at any time, follow steps 1 - 3 to turn on FM radio mode and cycle to the desired preset.

## Using FM Radio in Other Countries









Different areas of the world use different FM frequency steps and ranges. By default, this unit is set to USA frequency steps. To use the radio outside the USA:

1. Make sure unit is OFF.
2. *Press and hold* the **Power Button + Mode Button together for 5 seconds** until "USA" flashes in the display.
3. Turn the **Volume Knob** to cycle to your location: Europe, Japan, Australia, China or USA.
4. Press the **Mode Button** again to exit frequency setting mode. 2 beeps will confirm setting.

## Using Bluetooth: Pairing and Playing Your Device Using NFC

# Using the iBN10

This unit features wireless NFC pairing, which allows playing NFC-enabled devices to pair and play instantly. For pairing non-NFC devices, please see the following section “Pairing Your Device Manually”. The first time the unit is plugged in, it will enter auto-pairing mode. Follow steps below to pair.

1. Turn on your Bluetooth-enabled/NFC-enabled device and turn on NFC capability as described in the device’s user manual.
2. Place your NFC-enabled device in play mode.
3. Touch the  area of your playing NFC device against the  antenna area on top of the unit. The unit will turn on and enter automatic pairing mode, a beep will sound, the Bluetooth icon  on the display will flash and the status indicator ring will “spin” while the unit attempts to pair. “iHome iBN10” should appear on your device’s menu. If your device asks if you wish to pair, accept (select “Yes” or similar). Once paired with a device, the Bluetooth icon will stop flashing, 2 confirmation tones will sound and your music will play through the unit.
4. Press the  **Presets Button** to play or pause audio.
5. Press the  **Button** or  **Button** to go to the start or end of a track, press twice for previous or next track or *press and hold* to perform high speed search backwards or forwards within a track.
6. Turn the **Volume Knob** to adjust the volume on the unit. You can also adjust volume on your device.
7. When done listening, press the  **Power Button** to turn the unit OFF. Remember to turn off your audio device, too. Powering off the unit will disconnect Bluetooth device. To disconnect your device without powering unit off, simply touch it again on the  antenna area on top of the unit. To pair a device manually, please see the following “Pairing Your Device Manually” section.

## Using Bluetooth: Pairing Your Device Manually

# Using the iBN10

**NOTE:** See the iBN10 Bluetooth Connection Guide for complete pairing details.

The first time the unit is plugged in, it will enter auto-pairing mode. Otherwise, follow steps below to pair.

1. Turn on your Bluetooth-enabled device and turn on Bluetooth capability as described in the device's user manual.
2. *Press and hold* the  **Power/Pairing Button** located on top of the unit for 3 seconds. The unit will turn on and enter pairing mode, a beep will sound, the Bluetooth icon on the display will flash and the status indicator ring will "spin" while the unit attempts to pair. "iHome iBN10" should appear on your device's menu. If "Not Paired," "Not Connected" or similar message appears, select "iHome iBN10" on the device to begin/complete pairing. If your device asks for a password, enter **1234** on the keyboard of your device. If no device is paired within 2 minutes, a long beep will sound and the unit will revert to its previous state. To retry pairing, follow steps 1 – 2.
3. Once paired with a device, the Bluetooth icon will stop flashing and remain on the display and two confirmation beeps will sound. There should be an indication on your device that pairing is complete. On some devices, you must then select "Use as Audio Device (stereo)" or similar on the device's Bluetooth menu. Once paired, your device should link to the iBN10 whenever within range (about 33 feet).

When you power ON the speaker, it will automatically link with the previously paired Bluetooth device as long as that device is still within range (about 33 feet). To pair with a different device, follow steps 1 – 2 on page 8.

## Playing Audio Via Bluetooth





1. Press the **⏻ Power Button**. The unit will turn on in the last mode used (Bluetooth, FM or Aux).
2. Press and release the **Mode Button** as needed to cycle to Bluetooth mode, indicated by Bluetooth icon on the display.
3. Press the **▶|| Presets Button** to play or pause audio.
4. Press the **◀ Button** or **▶▶ Button** to go to the start or end of a track, press twice for previous or next track or *press and hold* to perform high speed search backwards or forwards within a track.
5. Turn the **Volume Knob** to adjust the volume on the unit. You can also adjust volume on your device.
6. When done listening, press the **⏻ Power Button** to turn the unit OFF. Remember to turn off your audio device, too. Powering off the unit will disconnect the current Bluetooth device. When powered back on, the unit will re-link to the last connected device.

**NOTE:** In Bluetooth AND Aux-in audio modes, if no audio is detected for 5 minutes, the unit will power down to save power.



## Using the Speakerphone feature

# Using the iBN10

NOTE: The unit must be powered and linked to a Bluetooth phone to receive a call.

1. When a call is received, playing music is muted to hear the ring tone. Press the  **Talk Button** to answer the call, or press the  **End Button** to ignore it. For call waiting function, press the  **Talk Button** to place a currently active call on hold and answer a new call; press the  **Talk Button** to switch between the calls.
2. When a call is completed, press the  **End Button** to end the call and resume previous function.

## Playing Audio via Aux In

1. Connect one end of the included stereo audio cable to the Aux-in jack on the back of the unit and connect the other end to the headphone or line-out jack on your audio device.
2. Press the  **Power Button** on the unit to turn it on.
3. Press and release the **Mode Button** as needed to cycle to Aux mode, indicated by AUX on the display.
4. Power on the audio device and use the controls on the device to play or pause audio, and navigate tracks. **Note:** pressing the  **Presets Button** while in Aux mode will MUTE/UNMUTE the unit.
5. Turn the **Volume Knob** to adjust the volume on the unit. You can also adjust volume on your device.
6. When done listening, press the  **Power Button** to turn the unit OFF. Remember to turn off your audio device, too.

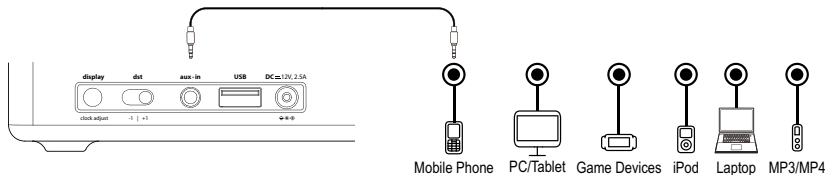

## Charging Devices via USB Port

# Using the iBN10

The unit will charge most mobile devices while connected to AC power

1. Connect the standard size end of a USB cable (not included) to the USB Port and connect the other end to the charging port on your device.
2. Monitor the charging on your device. If your device does not charge, you must charge your device using the charger that came with it.

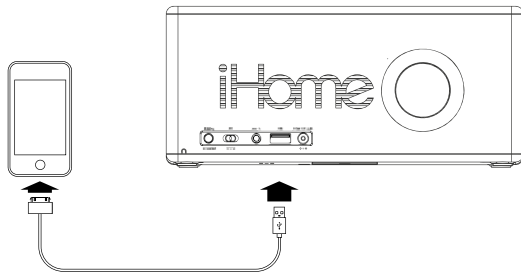
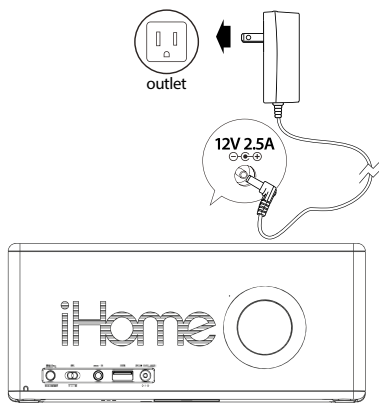

## Dimming the Display

When the unit is OFF, *press and hold* the Display/Clock Adjust Button for 5 seconds to adjust the display brightness from High to Low.

## Replacing and Installing Clock Backup Battery

# Using the iBN10

**Note:** 1 CR2450 battery is included with the unit.

**Remove pull tab before using the unit.**

This model is equipped with a battery backup circuit that will maintain the time and other settings in the event of a temporary power interruption (the display is NOT maintained). When the backup battery is getting weak the Low Backup Battery Indicator will flash for 10 seconds in the display when the unit is powered ON or OFF then disappear. When you see this flashing indicator you should replace the backup battery as soon as possible.

### To install/replace the backup battery:

**IMPORTANT:** When replacing the backup battery be sure to have the unit connected to the AC outlet to maintain all of your settings, otherwise it will be necessary to reset them after the battery is replaced.

1. Use a Phillips screwdriver to remove the battery door located on the bottom of the unit. If replacing battery, remove the exhausted battery.
2. Insert 1 fresh CR2450 battery in the backup battery compartment. Make sure the "+" side of the battery is facing toward you.
3. Replace the battery compartment door and tighten screw. Do not overtighten. Confirm that the backup battery indicator is not flashing in the display.

**Note:** Make sure you dispose of batteries properly (see your local regulations)

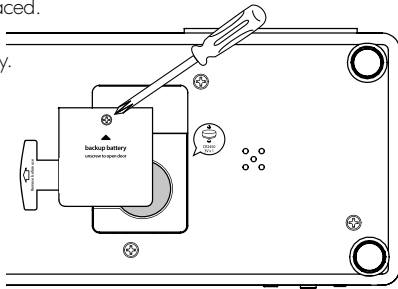

**WARNING:** Lithium batteries can explode or cause burns if disassembled, shorted, recharged, exposed to water, fire, or high temperatures. Do not place loose batteries in a pocket, purse, or other container containing metal objects, mix with used or other battery types, or store with hazardous or combustible materials. Store in cool, dry, ventilated area. Follow applicable laws and regulations for transport and disposal.



# Consumer Product Safety Guide

## IMPORTANT SAFETY INSTRUCTIONS

When used in the directed manner, this unit has been designed and manufactured to ensure your personal safety. However, improper use can result in potential electrical shock or fire hazards. Please read all safety and operating instructions carefully before installation and use, and keep these instructions handy for future reference. Take special note of all warnings listed in these instructions and on the unit.

1. **Water and Moisture** – The unit should not be used in water. For example: in a bathtub, washbowl, kitchen sink, laundry tub, swimming pool or in a wet basement.
2. **Ventilation** – The unit should be situated so that its location or position does not interfere with its proper ventilation. For example, it should not be situated on a bed, sofa, rug or similar surface that may block ventilation openings. Also, it should not be placed in a built-in installation, such as a bookcase or cabinet, which may impede the flow of air through the ventilation openings.
3. **Heat** – The unit should be situated away from heat sources such as radiators, heat registers, stoves or other appliances (including amplifiers) that produce heat.
4. **Power Sources** – The unit should be connected to a power supply only of the type described in the operating instructions or as marked on the appliance.
5. **Power – Cable Protection** – Power supply cables should be routed so that they are not likely to be walked on or pinched by items placed upon or against them. It is always best to have a clear area from where the cable exits the unit to where it is plugged into an AC socket.
6. **Cleaning** – The unit should be cleaned only using a warm damp cloth. Do not use solvents, etc.
7. **Objects and Liquid Entry** – Care should be taken so that objects do not fall and liquids are not spilled into any openings or vents located on the product.

8. **Attachments** – Do not use attachments not recommended by the product manufacturer.
9. **Lightning and Power Surge Protection** – Unplug the unit from the wall socket and disconnect the antenna or cable system during a lightning storm or when it is left unattended and unused for long periods of time. This will prevent damage to the product due to lightning and power-line surges.
10. **Overloading** – Do not overload wall sockets, extension cords, or integral convenience receptacles as this can result in a risk of fire or electric shock.
11. **Damage Requiring Service** – The unit should be serviced by qualified service personnel when:
  - A. the power supply cable or plug has been damaged.
  - B. objects have fallen into or liquid has been spilled into the enclosure.
  - C. the unit has been exposed to rain.
  - D. the unit has been dropped or the enclosure damaged.
  - E. the unit exhibits a marked change in performance or does not operate normally.
12. **Periods of Nonuse** – If the unit is to be left unused for an extended period of time, such as a month or longer, the power cable should be unplugged from the unit to prevent damage or corrosion.
13. **Servicing** – The user should not attempt to service the unit beyond those methods described in the user's operating instructions. Service methods not covered in the operating instructions should be referred to qualified service personnel.

Questions? Visit [www.ihome.com](http://www.ihome.com)  
or call 1-800-288-2792 Toll Free

## Unit doesn't respond (no power)

- Check that all connections are correct and properly plugged in.
- Only use the AC adaptor that came with the unit.
- Make sure your device is properly paired with the iBN10.
- Make sure the **Power** is ON, indicated by lit up Power Button.

## Unit doesn't respond

- If the unit appears to be “frozen” or locked up, you may need to reset it.
- To clear all Bluetooth devices, **press and hold the  Button** for at least 10 seconds. 1 long beep will confirm Bluetooth devices are cleared. You must then re-pair any Bluetooth devices.

## Trouble pairing device with iBN10

Bluetooth implementation varies depending on your device's hardware and operating system. Please see our website for updates on pairing.

- If auto “Pair and play” on your NFC-enabled device fails, make sure Bluetooth is turned on and screen is active (not dark) on NFC device. If pairing still fails, try to pair manually by pressing and holding the Pairing Button on the top of the unit for 2 seconds.
- Make sure your device is working properly. Check your device's manual for details on Bluetooth pairing and linking.

For further information and to see the latest instructions, visit [www.ihome.com/support](http://www.ihome.com/support)

# Limited 1 Year Warranty

iHome Products, a division of SDI Technologies Inc. (hereafter referred to as SDI), warrants this product to be free from defects in workmanship and materials, under normal use and conditions, for a period of one (1) year from the date of original purchase. Should this product fail to function in a satisfactory manner, it is best to first return it to the store where it was originally purchased. Should this fail to resolve the matter and service still be required by reason of any defect or malfunction during the warranty period, SDI will repair or, at its discretion, replace this product without charge. This decision is subject to verification of the defect or malfunction upon delivery of this product to the Factory Service Center authorized by Customer Service. If service is required, please call Customer Service at 1-800-288-2792 to obtain a Return Authorization Number and shipping instructions.

## Disclaimer of Warranty

NOTE: This warranty is valid only if the product is used for the purpose for which it was designed. It does not cover (i) products which have been damaged by negligence or willful actions, misuse or accident, or which have been modified or repaired by unauthorized persons; (ii) cracked or broken cabinets, or units damaged by excessive heat; (iii) damage to digital media players, CD's or tape cassettes (if applicable); (iv) the cost of shipping this product to the Factory Service Center and its return to the owner.

This warranty is valid only in the United States of America and does not extend to owners of the product other than to the original purchaser. In no event will SDI or any of its affiliates, contractors, resellers, their officers, directors, shareholders, members or agents be liable to you or any third party for any consequential or incidental damages, any lost profits, actual, exemplary or punitive damages.

(Some states do not allow limitations on implied warranties or exclusion of consequential damages, so these restrictions may not apply to you.) This warranty gives you specific legal rights, and you may also have other rights which vary from state to state.

Your acknowledgement and agreement to fully and completely abide by the above mentioned disclaimer of warranty is contractually binding to you upon your transfer of currency (money order, cashier's check, or credit card) for purchase of your SDI product.

© 2014 SDI Technologies, Inc. All rights reserved.  
Questions? Visit [www.ihome.com](http://www.ihome.com)  
or call 1-800-288-2792 Toll Free