

iHome®

Model: iBT78



*Color Changing Rechargeable
Bluetooth Speaker
with Speakerphone*



**CHARGE
BEFORE
USE**

instruction manual



Introduction

Thank you for purchasing the iHome iBT78. This product is designed to provide high quality wireless sound for your iPad, iPhone, iPod, computer, PDA or other Bluetooth audio device.

This instruction booklet explains the basic operation and care of the unit. Please read them carefully and keep for future reference.

Maintenance

- Place the unit on a level surface away from sources of direct sunlight or excessive heat.
- Protect your furniture when placing your unit on a natural wood and lacquered finish. A cloth or other protective material should be placed between it and the furniture.
- Clean your unit with a soft cloth moistened only with mild soap and water. Stronger cleaning agents, such as benzene, thinner or similar materials can damage the surface of the unit.

iBT78

What's Included

- iBT78 speaker
- Micro USB to USB charging cable
- Carry strap

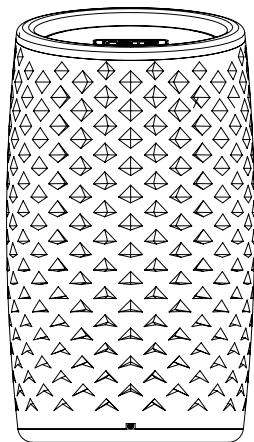

iBT78 speaker

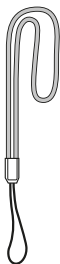

Carry strap



Micro USB to USB
charging cable

Meet Your iBT78

Top

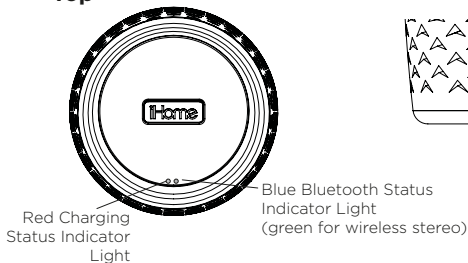

Front

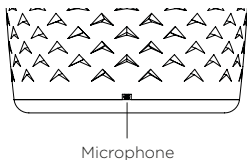

Bottom

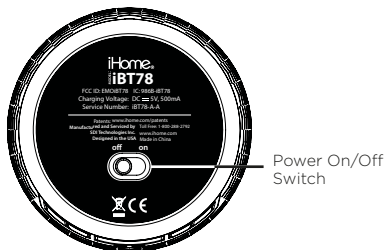

Back

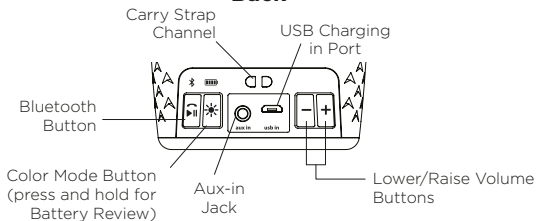

iBT78

Getting Started: Carry Strap

The iBT78 has a channel above the controls to attach the included carry strap. To attach the carry strap, form a small loop in one end of the carry strap. Insert this loop through the desired channel, then pull the loop back through the larger loop formed in the carry strap to tighten.

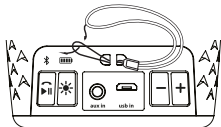

Charging the Unit

CHARGE UNIT BEFORE USE/KEEP UNIT OFF FOR FASTER CHARGING

1. Connect the micro USB plug on the included charging cable to the micro USB Charging in Port on the back of the unit.
2. Connect the standard USB plug end of the cable to a USB AC adapter connected to a working outlet or to another USB charging source. For first time use, charge unit for about 4 hours. The status indicator LED on top of the unit flashes red while charging and turns off once unit is fully charged. When charge level is low, it will also flash red when not connected to charging source.

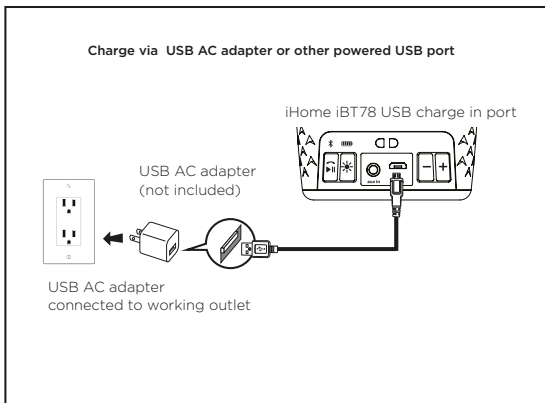

3. To review the charging status of the unit while it is charging, press and hold the  **Color Mode Button**. The cabinet lights will flash green from bottom to top for 12 seconds to show unit is charging.

Reviewing Battery Charge Level (Charger is Disconnected and unit is ON)

1. Press and hold the  **Color Mode Button** when unit is ON but not charging (micro USB cable not connected) to enter Battery Review Mode. The cabinet lights will blink and built-in voice will announce the current battery level.

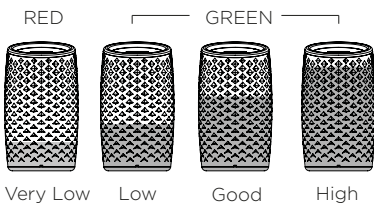

TIP: On some iOS (Apple) devices, you can view the iBT78 battery status on your device's screen. When device is paired and connected, look for a vertical battery icon next to the Bluetooth icon on the upper right corner of the device's screen.



Using the iBT78

Pairing Your Device

Pairing is the set-up process to introduce your Bluetooth-capable device to the iBT78. Once your device is paired, the iBT78 can recognize it and you can play your audio through it.



1. Turn on your Bluetooth device and make it “discoverable” by turning on Bluetooth mode (check in Options or Settings).

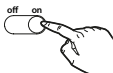

2. Slide the **Power On/Off Switch** to ON to turn on the iBT78. The first time the unit is powered on, it will enter auto-pairing mode: the unit will beep and the Bluetooth status indicator light on top of the unit will flash quickly while the unit attempts to pair. (If Color Mode is on, the cabinet lights will flash blue and red.) “iHome iBT78” should appear in your device’s Bluetooth menu. Select “iHome iBT78” on device to begin/complete pairing. If prompted for a passcode, enter “1234” on your device’s keypad. 1 beep will sound and the Bluetooth status indicator light will appear solid blue (in Color Mode, cabinet will flash blue twice), indicating the iBT78 is paired and ready to play music. There should also be an indication on your device. If no device is successfully paired within 3 minutes the iBT78 will default to previous mode.

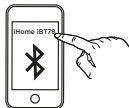

3. To pair with a different device or at a different time, make sure unit is powered on, then press and hold the **Bluetooth Button** for 2 seconds. Select “iHome iBT78” on device to pair.



Once the iBT78 is paired to a device, it will attempt to autolink when the device is within range (about 33 feet).



Using the iBT78

Playing Audio Via Bluetooth

1. Slide the **Power On/Off Switch** to **ON** to turn on the unit. The Bluetooth status indicator will glow solid blue when a linked device is in range and detected. You can then listen to audio streamed wirelessly from your paired Bluetooth device.
2. Press the  **Bluetooth Button** to play and pause tracks.
3. Press the **-** or **+** **Button** to adjust the iBT78 volume. You can also adjust volume on your device.
4. When done listening, slide the **Power On/Off Switch** to **OFF** turn the unit OFF. Remember to turn off your device, too.



Speakerphone Operation

NOTE: The unit must be powered on and linked to a Bluetooth phone to receive a call.

1. When a call is received, playing music is muted to hear the ring tone and the cabinet lights flash green. Press the  **Bluetooth Button** to answer the call, or press and hold to reject the call.
2. When a call is completed, press the  **Bluetooth Button** to end the call and resume previous function.

Wireless Stereo Mode

NOTE: The iBT78 is Wireless Stereo capable, and will play stereo through 2 linked speakers (2nd speaker sold separately) when linked.

1. **Power ON** each speaker.
2. *Press and hold* the  **Bluetooth Button** and the **- Minus Button** together on each speaker until the cabinets blink green, as will the status indicator on the right speaker. When linked, a voice will announce "Left Channel" and "Right Channel" and the status indicator on the right speaker will glow solid green. You can now play music through both speakers.
3. Press the  **Bluetooth Button** to play and pause tracks.
4. Press the **-** or **+** **Button** to adjust the volume on both speakers. You can also adjust volume on your device.
5. Note that powering off either speaker will turn both off.

Using the iBT78

Playing Audio via Aux In

1. Connect micro USB charging/audio cable to the Charging/Aux-in USB Port on the side of the unit and connect the 3.5mm audio plug end to the headphone or line-out jack on your audio device.
2. Slide the **Power On/Off Switch** to **ON** turn the unit ON.
3. Power on the audio device and use the controls on the device to play or pause audio and to navigate tracks.
4. Press the **-** or **+** Button to adjust the system volume. You can also adjust volume on your device.
5. When done listening, slide the **Power On/Off Switch** to **OFF** turn the unit OFF. Remember to turn off your device, too.

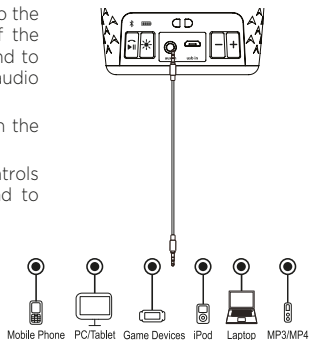

Using Color Modes

There are six color modes, which you cycle through in this order:

- a. Slow Fade (colors slowly fade from one into the next)
 - b. Fast Change (colors change rapidly)
 - c. One Color (select a favorite color)
 - d. Pulse to Music (lights flash to the beat of the music)
 - e. Preset Pulsing (each light array pulses through its own preset pattern of colors)
 - f. Off (no display)
1. Slide the **Power On/Off Switch** to **ON** turn the unit ON.
 2. Press the *** Color Mode Button** repeatedly to cycle to the desired color mode. For One Color mode, first cycle to Fast Change mode and press the Color Mode Button when the desired color appears. For Pulse to Music, make sure the volume on your connected Bluetooth device is above 30%.
 3. When done, slide the **Power On/Off Switch** to **OFF** turn the unit OFF.

Troubleshooting

Unit doesn't respond (no power/locked up/frozen)

- Make sure unit is completely charged.
- Check that all connections are correct and properly plugged in.
- Make sure your device is properly paired with the iBT78.
- Make sure the unit is on

If the unit does not respond, try resetting the unit. Press and hold both the “+” and “-” Buttons at the same time for about 10 seconds. Note that doing so will clear settings, and any Bluetooth devices will need to be re-paired.

Trouble pairing device with iBT78

Bluetooth implementation varies depending on your device's hardware and operating system. Please see our website for updates on pairing.

- When you power ON the speaker, it will automatically link with the last previously paired Bluetooth device if the device is still within range (about 33 feet).
- If your device does not auto-link when within range, re-pair the device. To do so, first delete the iBT78 from your Bluetooth devices menu.
- Make sure your device is working properly. Check your device's manual for details on Bluetooth pairing and linking.

**For further information and to see the latest instructions, visit
www.ihome.com/support**

Internal Rechargeable Lithium-ion Battery

This device uses an internal rechargeable lithium-ion battery that should last the lifetime of the device. If you suspect your battery may be dead, try charging it several times. If the battery does not recharge, please contact **Customer Service at -1-800-288-2792**.

WARNING/DISPOSAL OF UNIT

Please do NOT attempt to change the battery yourself. Doing so may damage the unit and will void the warranty. When disposing of unit, follow the disposal instructions below:

- Never dispose of used batteries/electronics with ordinary solid wastes, since they contain toxic substances.
- Always dispose of used batteries/electronics in accordance with the prevailing community regulations that apply to the disposal of batteries/electronics. If there are no local regulations concerning battery/electronics disposal, please dispose of the device in a waste bin for electronic devices.
- Many electronics retailers now recycle batteries and other electronic components at no charge. Check to see which ones in your area do so.

CAUTION

The battery used in this device may present a risk of fire, explosion or chemical burn if mistreated

- Never use or charge the battery if it appears to be leaking, discolored, deformed, or in any way abnormal.
- Never disassemble the unit or attempt to remove battery as that could cause leakage of alkaline solution or other electrolytic substance.
- Always confirm that the temperature is 5°C - 35° C (41° - 95° Fahrenheit) before you charge the battery. Leakage or deterioration of the battery may occur if this warning is not heeded.
- Never expose the battery to any liquid.
- Never expose the battery to excessive heat such as direct sunlight or fire. Never use the battery pack in an unventilated vehicle where excessive internal temperatures may be encountered.
- Always keep the battery out of the reach of infants and small children.

FCC Information

iBT78

FCC ID:EMOIBT78

IC:986B-iBT78

FCC Radiation Exposure Statement

This equipment complies with FCC RF radiation exposure limits set forth for an uncontrolled environment.

This device complies with Part 15 of the FCC Rules, operation is subject to the following two conditions: (1) This device may not cause harmful interference, and (2) this device must accept any interference received, including interference that may cause undesired operation.

- Warning: Changes or modifications to this unit not expressly approved by the party responsible for compliance could void the user's authority to operate the equipment.
- NOTE: This equipment has been tested and found to comply with the limits for a Class B digital device, pursuant to Part 15 of the FCC Rules.

These limits are designed to provide reasonable protection against harmful interference in a residential installation. This equipment generates, uses and can radiate radio frequency energy and, if not installed and used in accordance with the instructions, may cause harmful interference to radio communications.

However, there is no guarantee that interference will not occur in a particular installation. If this equipment does cause harmful interference to radio or television reception, which can be determined by turning the equipment off and on, the user is encouraged to try to correct the interference by one or more of the following measures:

- Reorient or relocate the receiving antenna.
- Increase the separation between the equipment and receiver.
- Connect the equipment into an outlet on a circuit different from that to which the receiver is connected.
- Consult the dealer or an experienced radio/TV technician for help.

CAN ICES-3 (B)/NMB-3(B)

Canada Statement

This device complies with Industry Canada's licence-exempt RSSs. Operation is subject to the following two conditions:

- (1) This device may not cause interference; and
- (2) This device must accept any interference, including interference that may cause undesired operation of the device.

Le présent appareil est conforme aux CNR d'Industrie Canada applicables aux appareils radio exempts de licence. L'exploitation est autorisée aux deux conditions suivantes :

- (1) l'appareil ne doit pas produire de brouillage;**
- (2) l'utilisateur de l'appareil doit accepter tout brouillage radioélectrique subi, même si le brouillage est susceptible d'en compromettre le fonctionnement.**

The device meets the exemption from the routine evaluation limits in section 2.5 of RSS 102 and compliance with RSS-102 RF exposure, users can obtain Canadian information on RF exposure and compliance.

Le dispositif rencontre l'exemption des limites courantes d'évaluation dans la section 2.5 de RSS 102 et la conformité à l'exposition de RSS-102 rf, utilisateurs peut obtenir l'information canadienne sur l'exposition et la conformité de rf.

Consumer Product Safety Guide

IMPORTANT SAFETY INSTRUCTIONS

When used in the directed manner, this unit has been designed and manufactured to ensure your personal safety. However, improper use can result in potential electrical shock or fire hazards. Please read all safety and operating instructions carefully before installation and use, and keep these instructions handy for future reference. Take special note of all warnings listed in these instructions and on the unit.

1. Water and Moisture – The unit should not be used near water. For example: near a bathtub, washbowl, kitchen sink, laundry tub, swimming pool or in a wet basement.
2. Ventilation – The unit should be situated so that its location or position does not interfere with its proper ventilation. For example, it should not be situated on a bed, sofa, rug or similar surface that may block ventilation openings. Also, it should not be placed in a built-in installation, such as a bookcase or cabinet, which may impede the flow of air through the ventilation openings.
3. Heat – The unit should be situated away from heat sources such as radiators, heat registers, stoves or other appliances (including amplifiers) that produce heat.
4. Power Sources – The unit should be connected to a power supply only of the type described in the operating instructions or as marked on the appliance. Only use the AC adapter that came with the unit.
5. Power-Cable Protection – Power supply cables should be routed so that they are not likely to be walked on or pinched by items placed upon or against them. It is always best to have a clear area from where the cable exits the unit to where it is plugged into an AC socket.
6. Cleaning – The unit should be cleaned only as recommended. See the Maintenance section of this manual for cleaning instructions.
7. Objects and Liquid Entry – Care should be taken so that objects do not fall and liquids are not spilled into any openings or vents located on the product.
8. Attachments – Do not use attachments not recommended by the product manufacturer.
9. Lightning and Power Surge Protection – Unplug the unit from the wall socket and disconnect the antenna or cable system during a lightning storm or when it is left unattended and unused for long periods of time. This will prevent damage to the product due to lightning and power-line surges.
10. Overloading – Do not overload wall sockets, extension cords, or integral convenience receptacles as this can result in a risk of fire or electric shock.
11. Damage Requiring Service – The unit should be serviced by qualified service personnel when:
 - A. the power supply cable or plug has been damaged.
 - B. objects have fallen into or liquid has been spilled into the enclosure.
 - C. the unit has been exposed to rain.
 - D. the unit has been dropped or the enclosure damaged.
 - E. the unit exhibits a marked change in performance or does not operate normally.
12. Periods of Nonuse – If the unit is to be left unused for an extended period of time, such as a month or longer, charge the unit fully before storage.
13. Servicing – The user should not attempt to service the unit beyond those methods described in the user's operating instructions. Service methods not covered in the operating instructions should be referred to qualified service personnel.
14. Magnetic Interference: This product's speakers contain powerful magnets which could cause interference or damage to sensitive equipment such as hard drives, CRT televisions and monitors, as well as medical, scientific, and navigational devices. Keep this unit away from these products at all times.

LIMITED 1 YEAR WARRANTY

iHome Products, a division of SDI Technologies Inc. (hereafter referred to as SDI), warrants this product to be free from defects in workmanship and materials, under normal use and conditions, for a period of one (1) year from the date of original purchase.

Should this product fail to function in a satisfactory manner, it is best to first return it to the store where it was originally purchased. Should this fail to resolve the matter and service still be required by reason of any defect or malfunction during the warranty period, SDI will repair or, at its discretion, replace this product without charge. This decision is subject to verification of the defect or malfunction upon delivery of this product to the Factory Service Center authorized by Customer Service.

If service is required, please call Customer Service at 1-800-288-2792 to obtain a Return Authorization Number and shipping instructions. A copy of the sales receipt is required to validate in-warranty status.

Disclaimer of Warranty

NOTE: This warranty is valid only if the product is used for the purpose for which it was designed. It does not cover (i) products which have been damaged by negligence or willful actions, misuse or accident, or which have been modified or repaired by unauthorized persons; (ii) cracked or broken cabinets, or units damaged by excessive heat; (iii) damage to digital media players, CD's or tape cassettes (if applicable); (iv) the cost of shipping this product to the Factory Service Center and its return to the owner.

This warranty is valid only in the United States of America and does not extend to owners of the product other than to the original purchaser. In no event will SDI or any of its affiliates, contractors, resellers, their officers, directors,

shareholders, members or agents be liable to you or any third party for any consequential or incidental damages, any lost profits, actual, exemplary or punitive damages. (Some states do not allow limitations on implied warranties or exclusion of consequential damages, so these restrictions may not apply to you.) This warranty gives you specific legal rights, and you may also have other rights which vary from state to state.

Your acknowledgment and agreement to fully and completely abide by the above mentioned disclaimer of warranty is contractually binding to you upon your transfer of currency (money order, cashier's check, or credit card) for purchase of your SDI product.

© 2017 SDI Technologies, Inc. All rights reserved
Questions? Visit www.ihome.com
or call 1-800-288-2792 Toll Free