

iHome



Model iBTW281

Wireless Charging Dual Alarm Clock Speaker System

QUESTIONS? visit www.ihome.com

WHAT'S INCLUDED:



1. iBTW281

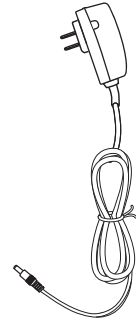

2. AC adapter

CONNECTING THE UNIT

Plug the included AC adapter into the DC jack on the back of the unit and connect the plug to a working outlet not controlled by a light switch.

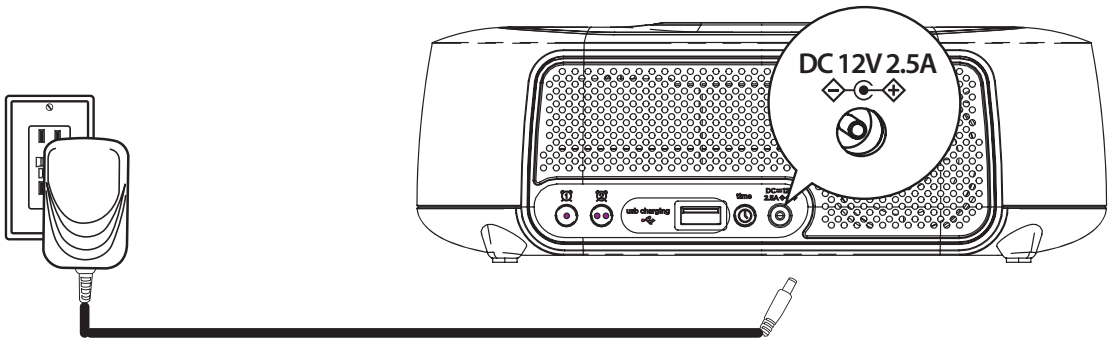

QUICK BLUETOOTH PAIRING

- Turn on your Bluetooth device and make it 'discoverable' by turning on Bluetooth mode.
- Press the **Power Button** on the iBTW281. The first time the unit is powered on, it will automatically enter pairing mode.
- Select 'iHome iBTW281' on your device's Bluetooth menu to connect!

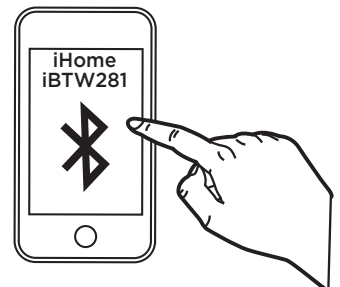
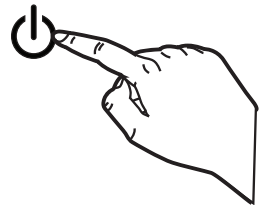

FEATURES & FUNCTIONS

TOP PANEL

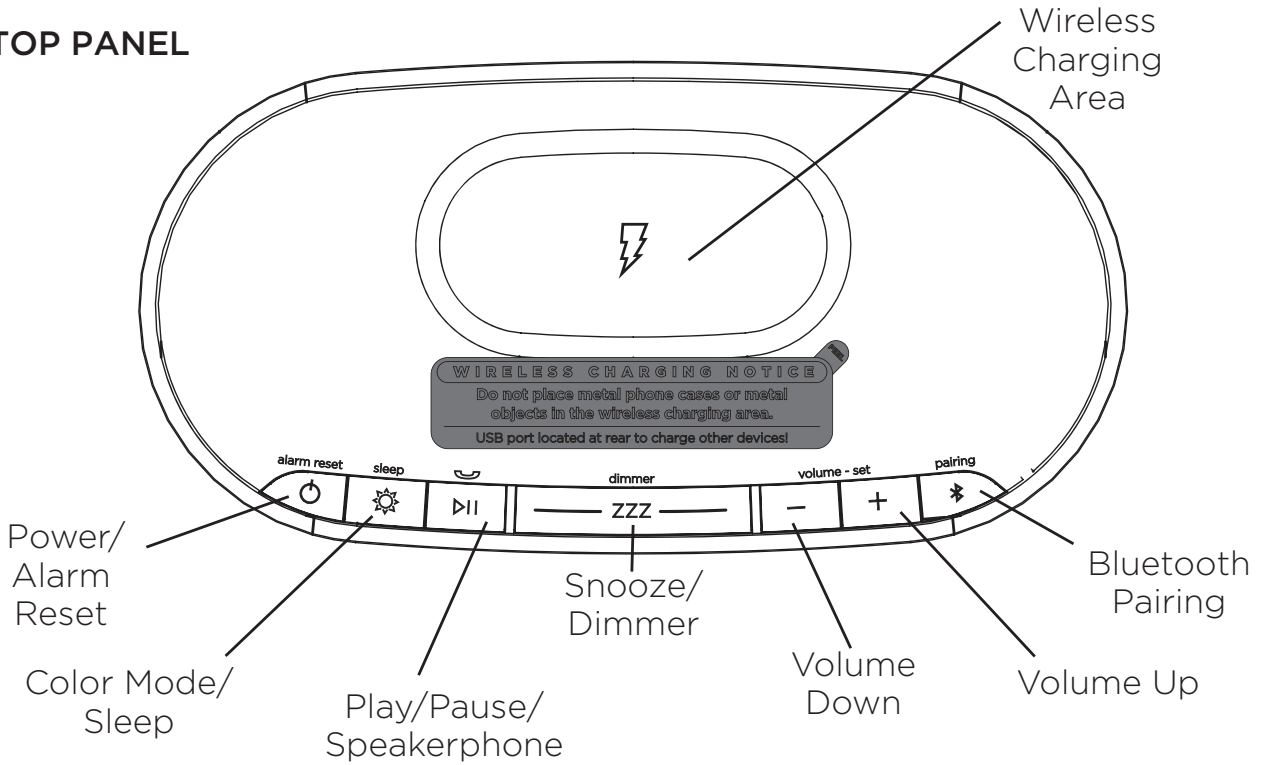

BACK PANEL

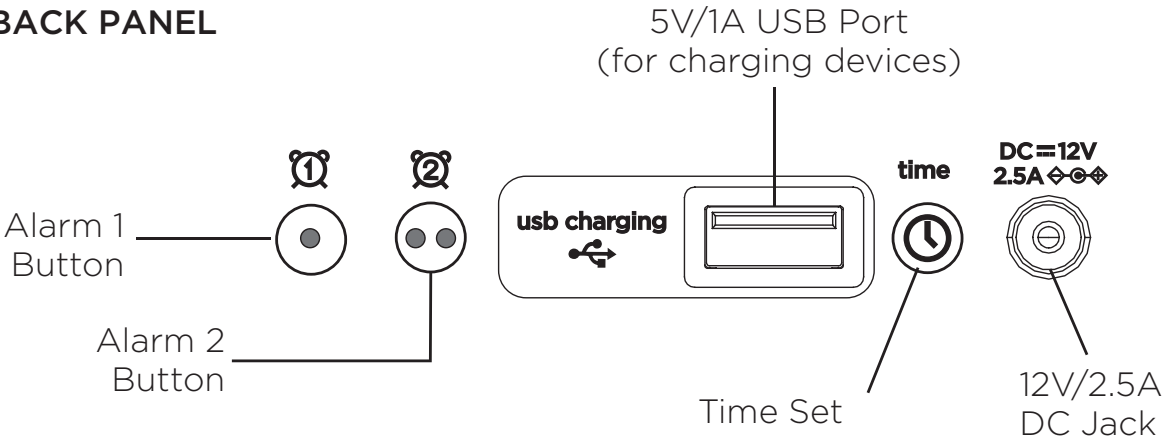

DISPLAY

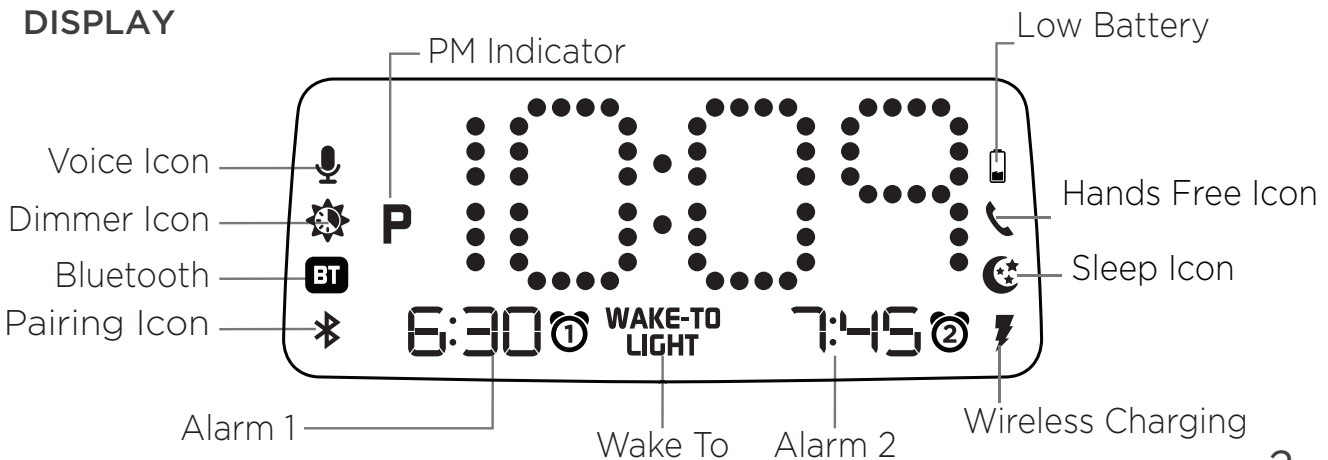

SETTING THE TIME

1. Press and hold the **⌚ Time Set Button** located on the back of the unit for 2 seconds until the clock display flashes and a beep sounds.
2. Press the **-** or **+** **Buttons** to adjust the clock to the current time (hold for rapid setting). Make sure you set the correct AM/PM time. The PM indicator appears to the left of the display; there is no AM indicator.
3. To toggle the clock display between standard 12 hour time and 24 hour (“military”) time display, press the **⌚ Alarm** or **⌚ Alarm Button** while the display is flashing during time setting.
4. Press and release the **⌚ Time Set Button** to confirm the current time setting. The YEAR will flash on the display. Press the **-** or **+** **Buttons** to set the correct year (hold for rapid adjustment).
5. Press and release the **⌚ Time Set Button** to confirm the current year setting. The Date will flash on the display. Press the **-** or **+** **Buttons** to set the correct month, then press the **Time Set Button** to confirm. Now press the **-** or **+** **Buttons** to set the day.
6. Press and release the **⌚ Time Set Button** to confirm the current date setting. 2 beeps will sound to indicate time setting mode is complete.

DAYLIGHT SAVINGS (DST) SWITCH

This unit has a **DST switch** on the bottom of the unit to adjust the time for daylight saving time and standard time. By default, it is set to Auto and will automatically adjust the time at the start and end of daylight saving time.

If you wish to adjust manually, slide the switch to +1 to add one hour or to -1 to subtract an hour.

SETTING AND USING THE ALARMS

This unit features dual alarms which can be set to different times and alarm sources. Each is set in the same way. Instructions are given as “Alarm Button”; use **Alarm 1 Button** or **Alarm 2 Button** to set respective alarms. **Note:** Each step must be completed while display is flashing or setting will time-out with any changes saved.

1. *Press and hold* the **Alarm Button** for 2 seconds until the alarm time display and alarm icon flash. A beep sounds.
2. Press the **-** or **+** **Buttons** to adjust the alarm time to the desired time (hold for rapid setting). Make sure you set the correct AM/PM alarm time. The PM indicator appears to the left of the display. (continued on next page...)

SETTING AND USING ALARMS (CONTINUED)

3. Press the **Alarm Button** to confirm the alarm time setting. The alarm schedule will flash: 7 (every day), 5 (weekdays) or 2 (weekend only). Press the **-** or **+** **Buttons** to select the desired alarm schedule.
4. Press the **Alarm Button** to confirm the alarm schedule. The wake-to source will flash.
5. Press the **-** or **+** **Buttons** to select the desired wake-to alarm source: Bluetooth, Tone or Light Only (no alarm sound).
Wake to Bluetooth: You will wake to the currently linked Bluetooth device. If no device is detected, the alarm will default to the last tone selected.
Wake to Tone: Press the **Alarm Button** to confirm. Press the **-** or **+** **Buttons** to select the desired tone to wake to (Tone 1 -Tone 4).
Wake to Light Only: Press the **Alarm Button** to confirm. Select this mode to wake to silent light only alarm. (You will then skip volume setting and advance to step 9 *Wake to Light* setting.)
6. Press the **Alarm Button** to confirm wake-to source. The alarm volume will flash (unless Wake to Light is set wake to choice, then volume setting is skipped and you are done).
7. Press the **-** or **+** **Buttons** to adjust the alarm volume.
8. Press the **Alarm Button** to confirm alarm volume. The current Wake to Light mode will flash.
9. Press the **-** or **+** **Buttons** to select the desired light mode to wake to (Slow Fade, Fast, One Color, Twinkle, Pulse, Sky Gradient, Nightlight, Off).
10. Press the **Alarm Button** to confirm the alarm settings and exit alarm setting mode. 2 beeps will confirm alarm setting is complete. The alarm icon will remain on the display, to show the alarm is armed.

*To preview the current alarm time, press and release the **Alarm Button**.

TURNING THE ALARM ON/OFF

1. Press the **Alarm Button** to toggle the alarm ON and OFF, indicated by the related white alarm indicator.
2. When the alarm sounds, press the corresponding **Alarm Button (1 or 2)** to disable the alarm and reset it to come on at the same time the next day.

SNOOZE/DIMMER

Snooze: When the alarm is sounding, press the **Dimmer/ZZZ Button** to snooze the alarm for 9 minutes.

Dimmer: Press the **Dimmer/ZZZ Button** (when alarm is NOT sounding) to adjust the display brightness.

PROGRAMMABLE SNOOZE + DIMMER

Adjust the snooze duration and set a schedule for your clock backlight to automatically dim and brighten at certain times of the day.

1. Press and hold the **Dimmer/ZZZ Button**.
2. Use the **+ or - Buttons** to adjust the snooze duration from 1-29 minutes. Press the **Dimmer/ZZZ Button** again to confirm.

Now it's time to set the display dimmer schedule:

3. Default is set to OFF. Toggle to ON by pressing the **+ Button** and then the **ZZZ Button** to confirm. (Note: Choosing OFF will simply exit the setting.)
4. Now choose the brightness level for daytime hours using the **+/- Buttons**. Press **ZZZ** again to confirm.
5. Now set the time you want the daytime dimmer to take effect. Use the **+/- Buttons** and press **ZZZ** again to confirm.
6. Now choose the brightness level for nighttime hours. Use the **+/- Buttons** and press **ZZZ** again to confirm.
7. Finally, set the time you want the nighttime dimmer to take effect. Use the **+/- Buttons** and press **ZZZ** again to confirm.
8. Done! The  icon will appear on the display when Dimmer Schedule is active.

MANUAL BLUETOOTH PAIRING

Make sure your device is 'discoverable' by turning on Bluetooth mode. The first time the iBTW281 is powered on, it will automatically enter pairing mode. Select 'iHome iBTW281' on your device's Bluetooth menu to connect.

To manually pair your Bluetooth device:

1. Press and hold the **Bluetooth Button** on the top of the iBTW281 for 2 seconds to enter pairing mode..

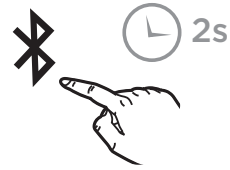

2. Select 'iHome iBTW281' on your device's Bluetooth menu to connect.

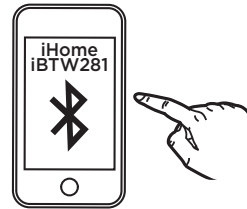

3. If pairing is successful, a voice prompt will announce "CONNECTED", then the Bluetooth icon appears on the display, indicating the iBTW281 is ready to play music.
4. To reset Bluetooth settings, press and hold the **Bluetooth Button** for 10 seconds.

PLAYING BLUETOOTH AUDIO

1. Press the **Play/Pause/Speakerphone Button** on the unit to play or pause audio from your linked Bluetooth device.
2. Press the **-** or **+** **Buttons** to adjust the volume on the unit.

SPEAKERPHONE

The iBTW281 must be ON and connected to a Bluetooth device in order to receive calls.

- Press the **Play/Pause/Speakerphone Button** to accept an incoming call.
- Press and hold the **Play/Pause/Speakerphone Button** to end or ignore a call.

WIRELESS CHARGING

This unit will wirelessly charge Qi compatible wireless charging phones. Place Qi compatible device face up on charging rest.

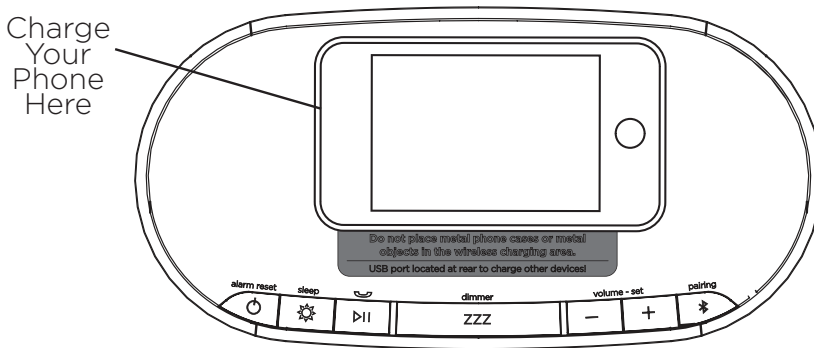

Check the lightning icon ⚡ on the iBTW281 display for charging status:

Slow blinking ⚡ icon: Device is charging properly.

Solid ⚡ icon: Device is charged.

Rapid blinking ⚡ icon: Device is not charging properly. Reposition device.

Note: The lightning icon may continue to blink slowly when iOS devices are fully charged.

CAUTION: Remove metal protective or magnetic case from phone before charging. When charging phone, do not place magnetic-stripped or other metal objects on the charger. Doing so could damage the object or this unit. Qi compatible phones with metallic looking finishes will charge normally.

COLOR MODES

Press the **Color Button** repeatedly to cycle through 8 different modes:

- Slow Fade
- Fast Change
- Favorite Color
- Twinkle
- Pulse to Music
- Sky Gradient
- Nightlight
- OFF

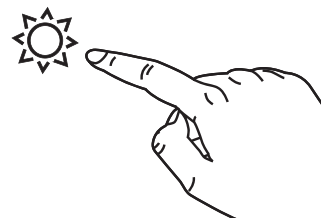

When in stand-by mode, press +/- to cycle through the color spectrum.

CHARGING DEVICES VIA USB

- Connect the standard size end of a USB cable (not included) to the USB Charging Port on the back of the unit. Connect the other end to the charging port on your device.
- Monitor the charging on your device. Some devices use a proprietary charging method and will not charge using the USB port. If this happens, you must charge your device using the charger that came with it.

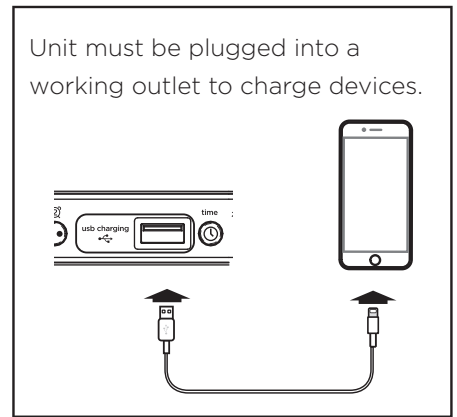

BATTERY BACK-UP

The unit comes with a CR-2450 back-up battery installed to maintain clock settings in the event of a temporary power failure. Remove the battery pull tab before use. When the battery icon on the display is flashing, it is time to replace the back-up battery.

1. Make sure the AC adapter is connected, or you will lose your time and alarm settings during battery replacement.
2. Use a Phillips screwdriver to open the battery compartment door.
3. Remove the exhausted battery from the compartment and insert 1 CR-2450 battery, checking that the + side is facing you. Replace the compartment door. Do not overtighten.

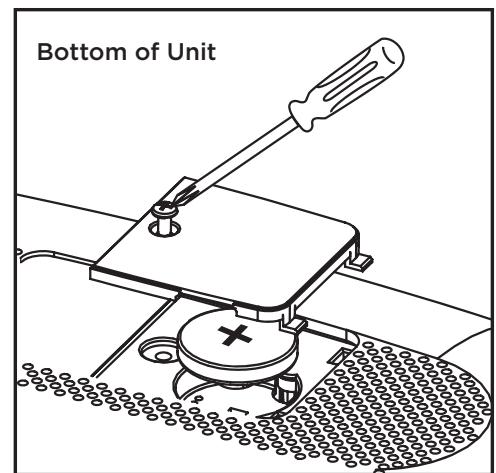

WARNING: Lithium batteries can explode or cause burns if disassembled, shorted, recharged, exposed to water, fire, or high temperatures. Do not place loose batteries in a pocket, purse, or other container containing metal objects, mix with used or other battery types, or store with hazardous or combustible materials. Store in cool, dry, ventilated area. Follow applicable laws and regulations for transport and disposal.

- Do not ingest the battery, Chemical Burn Hazard. This product contains a coin/button cell battery. If the coin/button cell battery is swallowed, it can cause severe internal burns in just 2 hours and can lead to death.
- Keep new and used batteries away from children. If the battery compartment does not close securely, stop using the product and keep it away from children. If you think batteries might have been swallowed or placed inside any part of the body, seek immediate medical attention.

IMPORTANT SAFETY INSTRUCTIONS

When used in the directed manner, this unit has been designed and manufactured to ensure your personal safety. However, improper use can result in potential electrical shock or fire hazards. Please read and follow all safety and operating instructions carefully before installation and use, and keep these instructions handy for future reference. Take special note of all warnings listed in these instructions and on the unit.

1. Water and Moisture – The unit should not be used near water. For example: near a bathtub, washbowl, kitchen sink, laundry tub, swimming pool or in a wet basement.
2. Ventilation – The unit should be situated so that its location or position does not interfere with its proper ventilation. For example, it should not be situated on a bed, sofa, rug or similar surface that may block ventilation openings. Also, it should not be placed in a built-in installation, such as a bookcase or cabinet, which may impede the flow of air through the ventilation openings.
3. Heat – The unit should be situated away from heat sources such as radiators, heat registers, stoves or other appliances (including amplifiers) that produce heat.
4. Power Sources – The unit should be connected to a power supply only of the type described in the operating instructions or as marked on the appliance. Only use the AC adapter that came with the unit.
5. Power-Cable Protection – Power supply cables should be routed so that they are not likely to be walked on or pinched by items placed upon or against them. It is always best to have a clear area from where the cable exits the unit to where it is plugged into an AC socket.
6. Cleaning – The unit should be cleaned only as recommended. See the Maintenance section for cleaning instructions.
7. Objects and Liquid Entry – Care should be taken so that objects do not fall and liquids are not spilled into any openings or vents located on the product.
8. Attachments – Do not use attachments not recommended by the product manufacturer.
9. Lightning and Power Surge Protection – Unplug the unit from the wall socket and disconnect the antenna or cable system during a lightning storm or when it is left unattended and unused for long periods of time. This will prevent damage to the product due to lightning and power-line surges.
10. Overloading – Do not overload wall sockets, extension cords, or integral convenience receptacles as this can result in a risk of fire or electric shock.
11. Damage Requiring Service – The unit should be serviced by qualified service personnel when:
 - A. the power supply cable or plug has been damaged.
 - B. objects have fallen into or liquid has been spilled into the enclosure.
 - C. the unit has been exposed to rain.
 - D. the unit has been dropped or the enclosure damaged.
 - E. the unit exhibits a marked change in performance or does not operate normally.
12. Periods of Nonuse – If the unit is to be left unused for an extended period of time, such as a month or longer, remove batteries before storage
13. Servicing – The user should not attempt to service the unit beyond those methods described in the user manual. Service methods not covered in the operating instructions should be referred to qualified service personnel.
14. Magnetic Interference: This product's speakers contain powerful magnets which could cause interference or damage to sensitive equipment such as hard drives, CRT televisions and monitors, as well as medical, scientific, and navigational devices. Keep this unit away from these products at all times.
15. Only use attachments/accessories specified by the manufacturer. This product is suitable for use in tropical and/or moderate climates.
16. The unit should be serviced by qualified service personnel when the enclosure damaged or does not operate normally.
17. No naked flame sources, such as lighted candles, should be placed on the apparatus.
18. WARNING: To reduce the risk of fire or electric shock, do not expose this product to rain or moisture”
19. CAUTION – Danger of explosion if battery is incorrectly replaced. Replace only with the same or equivalent type.
20. Do not dispose of batteries in the household trash or fire
21. The mains plug of power adaptor is used as the disconnect device, it shall remain readily operable.

MAINTENANCE

- Place the unit on a level surface away from sources of direct sunlight or excessive heat.
- Protect your furniture when placing your unit on a natural wood and lacquered finish. A cloth or other protective material should be placed between it and the furniture.
- Clean your unit with a soft cloth moistened only with mild soap and water. Stronger cleaning agents such as thinner or similar materials can damage the surface of the unit.

LIMITED ONE YEAR WARRANTY

iHome Products, a division of SDI Technologies Inc. (hereafter referred to as SDI), warrants this product to be free from defects in workmanship and materials, under normal use and conditions, for a period of one (1) year from the date of original purchase. Should this product fail to function in a satisfactory manner, it is best to first return it to the store where it was originally purchased. Should this fail to resolve the matter and service still be required by reason of any defect or malfunction during the warranty period, SDI will repair or, at its discretion, replace this product without charge. This decision is subject to verification of the defect or malfunction upon delivery of this product to the Factory Service Center authorized by Customer Service.

If service is required, please call Customer Service at 1-800-288-2792 to obtain a Return Authorization Number and shipping instructions. A copy of the sales receipt is required to validate in-warranty coverage.

Disclaimer of Warranty

NOTE: This warranty is valid only if the product is used for the purpose for which it was designed. It does not cover (i) products which have been damaged by negligence or willful actions, misuse or accident, or which have been modified or repaired by unauthorized persons; (ii) cracked or broken cabinets, or units damaged by excessive heat; (iii) damage to digital media players, CD's or tape cassettes (if applicable); (iv) the cost of shipping this product to the Factory Service Center and its return to the owner.

This warranty is valid only in the United States of America and does not extend to owners of the product other than to the original purchaser. In no event will SDI or any of its affiliates, contractors, resellers, their officers, directors, shareholders, members or agents be liable to you or any third party for any consequential or incidental damages, any lost profits, actual, exemplary or punitive damages. (Some states do not allow limitations on implied warranties or exclusion of consequential damages, so these restrictions may not apply to you.) This warranty gives you specific legal rights, and you may also have other rights which vary from state to state. Your acknowledgment and agreement to fully and completely abide by the above mentioned disclaimer of warranty is contractually binding to you upon your transfer of currency (money order, cashier's check, or credit card) for purchase of your SDI product.