

iCVBT500 - Quick Start Guide (English)  
Folded Size: 153 x 140 mm  
Color: 1C+1C  
Material: 120 gsm WF paper

July 14, 2021-V1



PMS Cool Gray 9C



Cover page

iHome Beauty

# HOLLYWOOD STUDIO XL

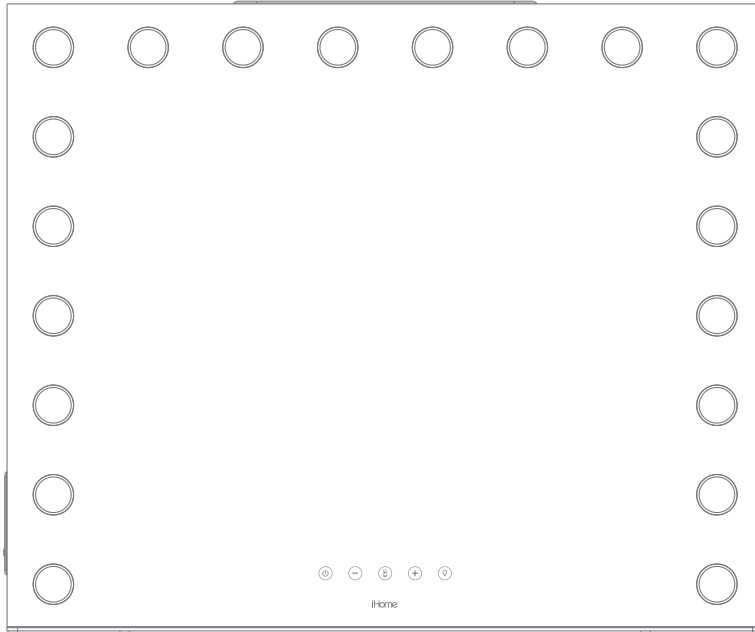

iCVBT500  
Quick Start Guide

# What's In the Box

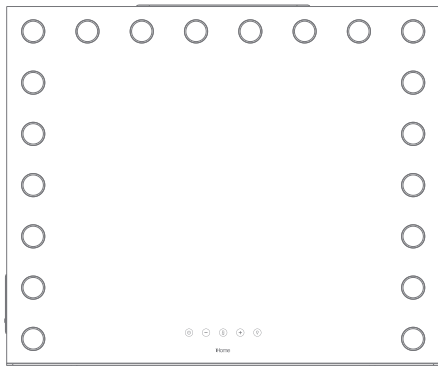

iCVBT500 Vanity Mirror



AC Adapter

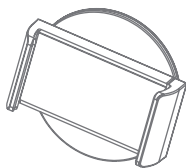

Removable Phone Holder

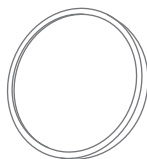

Removable Detail Mirror

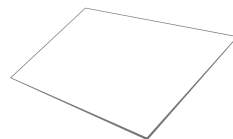

Cleaning Cloth

## Getting Started

- Connect included AC adapter to DC jack on back of mirror and the other end to a working wall outlet not controlled by a light switch.

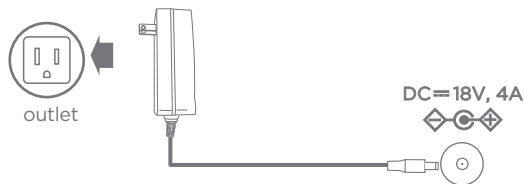

## Charging Devices

**Mirror MUST be connected to power for USB charging from the unit.**

This unit includes 2 standard USB ports for charging devices.

- Connect a USB-A charging cable (not included) to a USB port on the side of the mirror, and connect the other end to your device to charge.

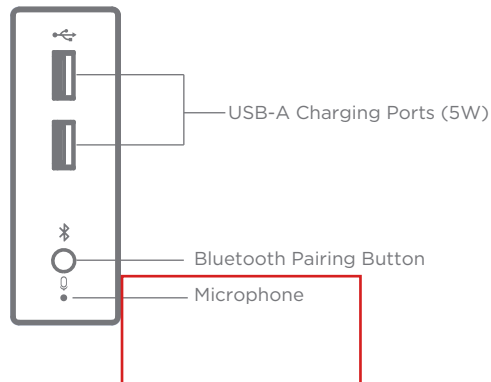

## Light Function



- Press and hold the Light Button to adjust the lighting mode: Soft Yellow, Warm White, or Bright White
- Press and release the Light Button to select a brightness level: 6/5/4/3/2/1/OFF

## Accessories

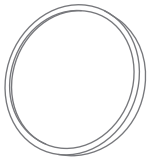

### Removable Detail Mirror

The back of the 10x magnifying detail mirror has SimpleStick™ micro suction material for easily attaching and detaching almost anywhere on non-porous surfaces. If necessary, clean SimpleStick material with office tape.

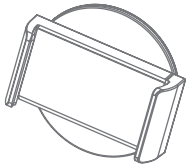

### Removable Phone Holder

The rotating phone holder has SimpleStick™ micro suction material for easily attaching and detaching almost anywhere on non-porous surfaces. If necessary, clean SimpleStick material with office tape.

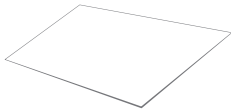

### Cleaning Cloth

Use the included cleaning cloth to keep the large surface and detail mirror smudge free.

# Bluetooth Audio Function



- Press power button to turn speaker On or Off
- When mirror is On, press and hold the Bluetooth button on side of mirror for 2 seconds for pairing mode, indicated by the blinking Voice Button



- Select “iHome HOLLYWOOD STUDIO XL” on your device’s Bluetooth menu to connect

To cancel pairing, press the Bluetooth button again

To reset Bluetooth, press and hold Bluetooth button for 10 seconds



- Press to play / pause Bluetooth audio
- Press to answer/end Bluetooth calls
- Press and hold for 2 seconds to decline Bluetooth calls
- Quick double press for next track
- Quick triple press for previous track
- Press and hold for 2 seconds and wait for beep to activate voice control with Siri® / Google Assistant™



- Press to lower or raise volume

Voice control requires an active internet connection on connected Bluetooth device with iOS 10 and Android 4.1 and later. When activated, the speaker microphone acts as an extension of the microphone in your smartphone to make/take calls, enable you to ask Siri/Google Assistant™ to play music and more.

## MAINTENANCE

- Place the unit on a level surface away from sources of direct sunlight or excessive heat.
- Protect your furniture when placing your unit on a natural wood and lacquered finish. A cloth or other protective material should be placed between it and the furniture.
- Clean your unit with a soft cloth moistened only with mild soap and water. Stronger cleaning agents such as thinner or similar materials can damage the surface of the unit.
- This mirror comes with a cleaning cloth to keep the large surface and detail mirror smudge-free.
- Wash the mirrors with mild soap and water as needed.
- Micro-suction (for 10x Detail Mirror or Removable Phone Holder) – to restore suction, use water (preferably with soap), wipe off any debris, and allow to air-dry before use to restore easy attachment again.

## IMPORTANT SAFETY INSTRUCTIONS

Please heed all warnings, read and follow all instructions and keep these instructions handy for future reference.

1. Do not use this product near water.
2. Unplug unit and clean only with damp cloth. Stronger cleaning agents, such as Benzene, thinner or similar materials can damage the surface of the unit.
3. Do not block any ventilation openings. Install in accordance with the manufacturer's instructions.
4. Heat – This product should be situated away from heat sources such as radiators, heat registers, stoves or other appliances (including amplifiers) that produce heat.
5. Only use attachments/accessories specified by the manufacturer.
6. Unplug this product during lightning storms or when unused for long periods of time.
7. Damage Requiring Service – This product should be serviced by qualified service personnel when:
  - Plug has been damaged.
  - Objects have fallen into or liquid has been spilled into the enclosure.
  - The unit has been exposed to rain. The unit has been dropped or the enclosure damaged.
  - The unit exhibits a marked change in performance or does not operate normally.
8. No naked flame sources, such as lighted candles, should be placed on this product.
9. Attention should be drawn to the environmental aspects of battery disposal.
10. This product is suitable for use in tropical and/or moderate climates.

### WARNING:

- To reduce the risk of fire or electric shock, do not expose this product to rain or moisture.
- Do not dispose of batteries in the household trash or fire.
- The mains plug of power adaptor is used as the disconnect device, it shall remain readily operable.
- Sunlight: Never place the mirror in or expose the mirror to direct sunlight. The sun's rays can reflect to become focused and cause excessive heat and/or fire. Do not use mirror in direct sunlight as reflected sunlight could injure eyes

## FCC INFORMATION

This equipment complies with FCC RF radiation exposure limits set forth for an uncontrolled environment.

This device complies with Part 15 of the FCC Rules, operation is subject to the following two conditions:

(1) This device may not cause harmful interference, and (2) this device must accept any interference received, including interference that may cause undesired operation.

- Warning: Changes or modifications to this unit not expressly approved by the party responsible for compliance could void the user's authority to operate the equipment.
- NOTE: This equipment has been tested and found to comply with the limits for a Class B digital device, pursuant to Part 15 of the FCC Rules.

These limits are designed to provide reasonable protection against harmful interference in a residential installation. This equipment generates, uses and can radiate radio frequency energy and, if not installed and used in accordance with the instructions, may cause harmful interference to radio communications.

However, there is no guarantee that interference will not occur in a particular installation. If this equipment does cause harmful interference to radio or television reception, which can be determined by turning the equipment off and on, the user is encouraged to try to correct the interference by one or more of the following measures:

- Reorient or relocate the receiving antenna.
- Increase the separation between the equipment and receiver.
- Connect the equipment into an outlet on a circuit different from that to which the receiver is connected.
- Consult the dealer or an experienced radio/TV technician for help.

This equipment should be installed and operated with minimum distance 20cm between the radiator & your body.

## ISED Information

This equipment complies with IC RSS-102 radiation exposure limits set forth for an uncontrolled environment.

This device contains licence-exempt transmitter(s)/receiver(s) that comply with Innovation, Science and Economic Development Canada's licence-exempt RSS(s). Operation is subject to the following two conditions:

(1) This device may not cause interference.

(2) This device must accept any interference, including interference that may cause undesired operation of the device.

The device complies with ISED RF exposure requirements, users can obtain Canadian information on RF exposure and compliance.

This equipment should be installed and operated with a minimum distance of 20 cm between the radiator and your body.

Any Changes or modifications not expressly approved by the party responsible for compliance could void the user's authority to operate the equipment.

Cet équipement est conforme aux limites d'exposition aux radiations IC CNR-102 établies pour un environnement non contrôlé.

L'émetteur/récepteur exempt de licence contenu dans le présent appareil est conforme aux CNR d'Innovation, Sciences et Développement économique Canada applicables aux appareils radio exempts de licence. L'exploitation est autorisée aux deux conditions suivantes :

(1) L'appareil ne doit pas produire de brouillage;

(2) L'appareil doit accepter tout brouillage radioélectrique subi, même si le brouillage est susceptible d'en compromettre le fonctionnement. L'appareil est conforme aux exigences d'exposition RF ISED, les utilisateurs peuvent obtenir des informations canadiennes sur l'exposition aux RF et la conformité.

Cet équipement doit être installé et utilisé avec une distance minimale de 20 cm entre le radiateur et votre corps.

Tout changement ou modification non expressément approuvé par la partie responsable de la conformité peut annuler l'autorité de l'utilisateur à utiliser l'équipement.

CAN ICES-3(B) / NMB-3(B)

## WARRANTY

For product support information and warranty please visit:  
[www.ihome.com/support](http://www.ihome.com/support)

© 2021 SDI Technologies, Inc. All rights reserved  
Questions? Visit [www.ihome.com](http://www.ihome.com)

The iHome logo is displayed in white text on a dark grey rounded rectangular background. The 'i' is lowercase and the 'Home' is title case.