

iHome

works with



iHome+apps
available on the App Store

Model iPL8

stereo alarm clock to charge
your iPod or iPhone



QUESTIONS? Visit www.ihomeaudio.com

W E L C O M E

Thank you for choosing the iPL8 from iHome. This user guide will get you up and running quickly and provide helpful hints to maximize enjoyment. For more information about this and other iHome products, please visit www.ihomeaudio.com. Note that details on using iHome apps with this unit are not covered in this booklet. For information on using iHome apps, please visit www.ihomeaudio.com/apps

GETTING STARTED

This unit ships with the following items. Please check to see that all items are present.

- 1 iPL8 speaker system
- 2 100-240V Universal AC power adaptor

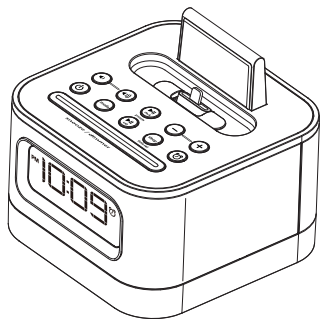

FEATURES & FUNCTIONS

Top panel

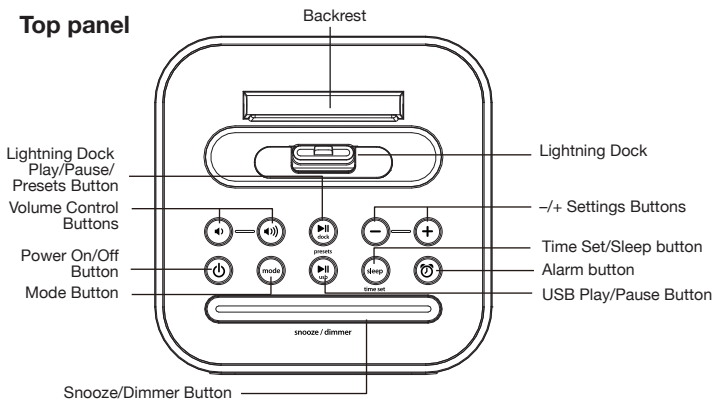

Back panel

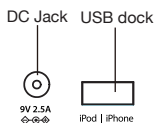

Display

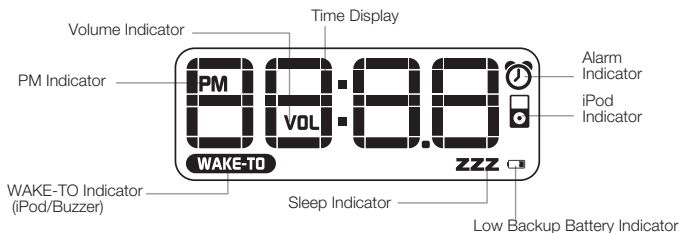

CONNECTING TO AC POWER

This unit operates on AC power using the included 100V-240V universal AC adaptor for charging and playing your iPhone or iPod . Place unit on a stable surface. Plug the power adaptor into the DC jack on back of the unit and the other end into a working wall socket. You can now charge your iPhone or iPod.

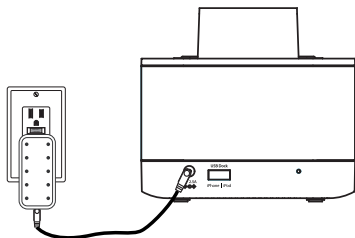

BACKUP BATTERY

The iPL8 ships with a CR2450 battery installed for backup to provide continuous alarm operation and clock settings in the event of a power failure.

Remove the pull tab from the battery compartment on the bottom of the unit before use. If a power failure occurs or the AC cord is accidentally disconnected, the display backlight will not remain lit, but current time and alarm time settings will be temporarily maintained. Otherwise, you must reset the time and alarm settings.

Note: The  **Battery Low icon** is located at the right side of clock display.

When the backup battery is low and needs to be replaced, the Battery Low icon will flash. To replace, follow steps below:

BACKUP BATTERY (CONTINUED)

1. Please make sure the AC adaptor is connected. Otherwise all settings may be lost during battery replacement.
2. Use a Phillips screwdriver to open the backup battery compartment door located on the bottom of the unit.
3. Remove the exhausted battery. Insert a new CR2450 battery by easing it under the tabs in the battery well and pressing down. Make sure the side marked + is facing up.
4. Close the battery compartment door and tighten the battery door screw.

Note: Make sure you dispose of battery properly (see your local regulations).

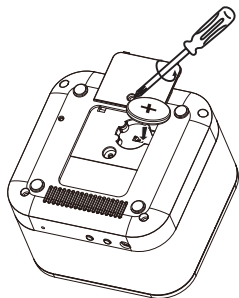

WARNING: Lithium batteries can explode or cause burns if disassembled, shorted, recharged, exposed to water, fire, or high temperatures. Do not place loose batteries in a pocket, purse, or other container containing metal objects, mix with used or other battery types, or store with hazardous or combustible materials. Store in cool, dry, ventilated area. Follow applicable laws and regulations for transport and disposal.

SETTING THE TIME: TIME SYNC & MANUAL TIME SETTING

TIME SYNC

This unit is equipped with auto sync. By default, the unit will sync to the time on your iPhone or newer iPod (iPod touch, iPod nano and iPod Classic; older iPod models such as iPod mini do not support this feature) whenever you dock it in the Lightning dock OR connect via the USB port located on back of the unit. During time sync, "SYNC" will flash on the display, indicating attempted time sync. When successful, the updated time will appear on the display. If sync is unsuccessful, try to sync again using a different iPhone or iPod. If sync still doesn't work, set the time manually (see below).



SETTING THE TIME MANUALLY

1. Press and hold the **Time Set Button** until "MAN" or "SYNC" flashes in the display with one beep. If "SYNC" is displayed, press the **+ or - Buttons** so "MAN" appears in the display, indicating manual time setting mode.
2. Press and release the **Time Set Button**. The time will flash in the display.
3. Press the **+ or - Buttons** to set the correct time (hold for rapid adjustment. Make sure you are setting the time to the correct AM or PM time. The PM indicator appears at the upper left of the display; there is no AM indicator. **NOTE:** The time can be set to standard 12 hour time (AM and PM) or to 24 hour time (sometimes called "military time"). To toggle between 12 and 24 modes, press and release the  **Alarm Button** located on top of the unit at any time during manual time setting mode.
4. Press and release the **Time Set Button** to confirm the current time setting (two beeps will sound) and exit time setting mode.

SETTING AND USING THE ALARM

SETTING THE ALARM

This unit lets you wake to your docked iPhone, iPod (iPod), USB-connected device (USB), FM radio or to the built-in buzzer alarm. The alarm will sound for 60 minutes or until reset/turned off.



1. Press and hold the  **Alarm Button** until the alarm time display flashes with one beep.
2. Press the **+ or - Buttons** to adjust the display to the desired alarm time (hold for rapid adjustment). Remember to set the correct AM or PM alarm time.
3. Press the  **Alarm Button** to confirm the alarm time. The WAKE-TO indicator will flash on the display. Press the **+ or - Buttons** to toggle among wake to Lightning dock, USB, FM radio or buzzer, then press the  **Alarm Button** to access volume setting for the selected alarm source.

Wake to iPod: If wake to dock (iPod) is selected, press the **+ or - Buttons** to set the Lightning dock volume (can be set from 5- 40). The alarm will wake you to the last track played on your docked iPhone or iPod.



Wake to USB: If wake to USB is selected, press the **+ or - Buttons** to set the USB dock volume (can be set from 5- 40). The alarm will wake you to the last track played on the iPhone or iPod connected to the USB dock.





Wake to radio: If wake to FM is selected, press the **+ or - Buttons** to select a radio station to wake to, then confirm your selection by pressing the  **Alarm Button**. Press the **+ or - Buttons** to set the FM radio alarm volume (can be set from 5- 40).

Wake to Buzzer: If wake to Buzzer is selected, press the **+ or - Buttons** to choose HI or LO buzzer alarm volume.

4. Press the  **Alarm Button** to exit and confirm alarm settings. An alarm  icon will appear on the display, indicating that the alarm is set and armed.

REVIEWING AND RESETTING THE ALARM

Press and release the  **Alarm Button** at any time to review the current alarm settings. To toggle the alarm on or off, press the  **Alarm Button** as needed. When the alarm icon is displayed, the alarm is armed/on.

Press the  **Power Button** or  **Alarm Button** when the alarm is sounding to reset it to come on again at the same time the next day. Press the   **Alarm Button** again to turn off/disarm the alarm. The alarm icon will disappear.

CHARGING YOUR IPHONE OR IPOD

1. Gently dock your iPhone or iPod into the flexible Lightning dock located on the top of the unit OR connect an iPhone or iPod to the USB dock on back of unit using the cable that came with your device.



While your iPhone/iPod is docked in the unit and/or connected via the USB dock and the unit is connected to AC power, it recharges (until fully charged). The unit will not overcharge your iPhone/iPod.

Note that non-docking iPod models will NOT charge.

Note: Please make sure your iPhone/iPod is properly docked into the unit. Failure to do so may damage your iPhone/iPod.

LISTENING TO YOUR IPHONE/IPOD USING THE LIGHTNING DOCK OR USB DOCK

USING THE LIGHTNING DOCK

1. Dock your already playing iPhone/iPod. The unit will automatically turn on and you will hear the music playing from your iPhone/iPod. The iPhone/iPod Icon will appear at the right side of the display, indicating iPhone/iPod playing mode.
2. Press the  or  **Buttons** on the unit to adjust the system volume.

Note: If the volume is too low on the iPhone/iPod, the unit may not detect that the iPhone/iPod is in play mode. Press the  **Dock Button** to play it. Press again as needed to pause and resume play.

3. Press the **+** or **- Buttons** to go to the next or previous track (hold to scan backwards or forwards within a track).
4. Press the  **Power Button** to turn off the unit. You can also turn the unit off by undocking a playing device.

NOTE: Press the **Mode Button** to cycle from iPod (Lightning dock) to USB to FM radio modes.

USING THE USB DOCK

1. Connect your already playing iPhone/iPod to the USB dock on back of unit using that cable that came with your device. The unit will automatically turn on and you will hear the music playing from your iPhone/iPod. The iPhone/iPod Icon will appear at the right side of the display, indicating iPhone/iPod playing mode.

2. Press the **◀** or **▶** **Buttons** on the unit to adjust the system volume.

Note: If the volume is too low on the iPhone/iPod, the unit may not detect that the iPhone/iPod is in play mode. Press the **▶** **USB Button** to play it. Press again as needed to pause and resume play.

3. Press the **+** or **- Buttons** to go to the next or previous track (hold to scan backwards or forwards within a track).

4. Press the **⏻ Power Button** to turn off the unit. You can also turn the unit off by disconnecting a device playing through the USB dock.

NOTE: Press the **Mode Button** to cycle from iPod (Lightning dock) to USB to FM radio modes.

LISTENING TO FM RADIO

Tuning and Playing the Radio

1. Press and release the **⏻ Power Button** to turn on the unit, then press and release the **Mode Button** as needed to cycle through dock, USB, and FM radio modes.

2. When FM mode is selected, press the **+** or **- Buttons** to tune the radio to a desired station. The current radio frequency appears in the bottom of the display. Press the **+** or **- Buttons** for a few seconds to scan for the next clear station.

3. **To memorize a station as a preset:**

A. Press the **▶ Dock Button** as needed to step through the 6 presets (P1 - P6) to the number you wish to assign, and then *hold* the **▶ Dock Button** until the selected preset number begins flashing in the display.

B. Press the **+** or **- Buttons** to tune the radio to a desired station. Hold briefly to have the radio autoscan/search for the next clear station.

C. Press the **▶ Dock Button** to confirm the setting, two confirmation beeps will confirm the setting and the preset number you wish to assign. Repeat steps A-C to preset up to 6 stations.

4. To listen to a preset station, use the **Mode Button** to select FM mode, then press the **▶ Dock Button** to choose the desired preset.

5. Press the **◀** or **▶** **Button** on the unit to adjust the system volume.

USING THE UNIT IN OTHER COUNTRIES

Different regions of the world use different FM radio frequency steps and ranges. You will need to select the one that matches the standards in your region (USA, EUROPE, JAPAN, AUSTRALIA, or CHINA). The default setting is USA; if you live in the US, you may skip this section.

1. Press and release the  **Power Button** to turn on the unit, then press and release the **Mode Button** as needed to cycle to FM radio mode.
2. Press and hold the **Mode Button** for about 5 seconds until the region flashes in the lower part of the display and a beep sounds.
3. Press the **+ or - Buttons** as needed to set the display to your region: USA, EU (Europe), JPN (Japan), AUS (Australia), or CHN (China).
2. Press and release the **Mode Button** (or no button within 10 seconds) to exit the radio frequency setting mode. Two beeps will confirm radio frequency setting.

SNOOZE/DIMMER OPERATION

1. To program a custom snooze duration, during normal operation (when alarm is not sounding) press and hold the **Snooze/Dimmer Button** until the display flashes, then press the **+ and - Buttons** on the unit to adjust the snooze time to 1 - 29 minutes.
2. Press the **Snooze/Dimmer Button** on the iPL8 after the alarm sounds. The alarm will be silenced and will come on again in about 9 minutes (default). You may repeat this cycle several times during the one hour alarm cycle.
3. During normal operation (when alarm is not sounding), press the **Snooze/Dimmer Button** to control the brightness (high, medium, low and off settings) of the LCD display.

S L E E P M O D E

Sleep mode lets you sleep to your playing docked or USB connected iPhone or iPod or to FM radio. Press the **Sleep Button** as needed to cycle to the desired sleep duration: 120, 90, 60, 30 or 15 minutes or OFF (turns sleep mode off). Press the ◀ or ▶ **Button** on the unit to adjust sleep listening level. The unit will revert to normal volume level when sleep mode ends. Press the **Sleep Button** during sleep to view the remaining sleep time; press again to set sleep to next (lower) sleep duration.

M A I N T E N A N C E

- Place the unit on a level surface away from sources of direct sunlight or excessive heat.
- Protect your furniture when placing your unit on a natural wood and lacquered finish. A cloth or other protective material should be placed between it and the furniture.
- Clean your unit with a soft cloth moistened only with mild soap and water. Stronger cleaning agents, such as Benzene, thinner or similar materials can damage the surface of the unit.

TROUBLESHOOTING

Symptom	Possible reason	Solution
Unit won't turn on	AC adaptor isn't plugged into a working wall socket or not plugged into the power jack on back of the unit	Plug the AC adaptor into a working wall socket and plug the connector into the supply jack on the unit. Make sure any associated wall switch that controls the outlet the is ON.
Device does not respond to the unit and/or device is playing but no sound comes out	Unit is not properly connected to power source and/or Power Button is not ON/device is paused	Make sure the unit is properly connected to AC power source. Check that the Power Button is lit up, indicating the unit is ON. Try adjusting volume on unit and audio device. Press the Mode Button to select the iPod (dock), USB or FM mode. Also try pressing the Play/Pause Button.
Erratic performance	External interference	Move unit away from potential sources of external interference such as computers, modems, wireless devices (routers) or fluorescent light.
No sound	Volume is too low	Turn volume up on your device
Sound distorted	Volume is too high	Turn volume down on your device
	Sound source is distorted	If the original sound file (MP3) is old or of poor quality, distortion and noise are easily noticed with high-power speakers. Try upgrading file from a trusted source such as iTunes.
Device doesn't charge up	Unit is not properly connected to AC power	Please make sure the unit is connected to a working power outlet. The unit will not charge while operating on backup battery

IMPORTANT SAFETY TIPS

When used in the directed manner, this unit has been designed and manufactured to ensure your personal safety. However, improper use can result in potential electrical shock or fire hazards. Please read all safety and operating instructions carefully before installation and use, and keep these instructions handy for future reference. Take special note of all warnings listed in these instructions and on the unit.

1. **Water and Moisture** – The unit should not be used near water. For example: near a bathtub, washbowl, kitchen sink, laundry tub, swimming pool or in a wet basement.
2. **Ventilation** – The unit should be situated so that its location or position does not interfere with its proper ventilation. For example, it should not be situated on a bed, sofa, rug or similar surface that may block ventilation openings. Also, it should not be placed in a built-in installation, such as a bookcase or cabinet, which may impede the flow of air through the ventilation openings.
3. **Heat** – The unit should be situated away from heat sources such as radiators, heat registers, stoves or other appliances (including amplifiers) that produce heat.
4. **Power Sources** – The unit should be connected to a power supply only of the type described in the operating instructions or as marked on the appliance.
5. **Power-Cable Protection** – Power supply cables should be routed so that they are not likely to be walked on or pinched by items placed upon or against them. It is always best to have a clear area from where the cable exits the unit to where it is plugged into an AC socket.
6. **Cleaning** – The unit should be cleaned only as recommended. See the Maintenance section of this manual for cleaning instructions.
7. **Objects and Liquid Entry** – Care should be taken so that objects do not fall and liquids are not spilled into any openings or vents located on the product.
8. **Attachments** – Do not use attachments not recommended by the product manufacturer.
9. **Lightning and Power Surge Protection** – Unplug the unit from the wall socket and disconnect the antenna or cable system during a lightning storm or when it is left unattended and unused for long periods of time. This will prevent damage to the product due to lightning and power-line surges.
10. **Overloading** – Do not overload wall sockets, extension cords, or integral convenience receptacles as this can result in a risk of fire or electric shock.
11. **Damage Requiring Service** – The unit should be serviced by qualified service personnel when:
 - A. the power supply cable or plug has been damaged.
 - B. objects have fallen into or liquid has been spilled into the enclosure.
 - C. the unit has been exposed to rain.
 - D. the unit has been dropped or the enclosure damaged.
 - E. the unit exhibits a marked change in performance or does not operate normally.

IMPORTANT SAFETY TIPS (CONTINUED)

12. Periods of Non use – If the unit is to be left unused for an extended period of time, such as a month or longer, the power cable should be unplugged from the unit to prevent damage or corrosion.
13. Servicing – The user should not attempt to service the unit beyond those methods described in the user's operating instructions. Service methods not covered in the operating instructions should be referred to qualified service personnel.
14. Magnetic Interference: This product's speakers contain powerful magnets which could cause interference or damage to sensitive equipment such as hard drives, CRT televisions and monitors, as well as medical, scientific, and navigational devices. Keep this unit away from these products at all times.

A GUIDE TO PRODUCT SAFETY

This device complies with Part 15 of the FCC Rules, operation is subject to the following two conditions: (1) This device may not cause harmful interference, and (2) this device must accept any interference received, including interference that may cause undesired operation.

- Warning: Changes or modifications to this unit not expressly approved by the party responsible for compliance could void the user's authority to operate the equipment.
- NOTE: This equipment has been tested and found to comply with the limits for a Class B digital device, pursuant to Part 15 of the FCC Rules.

These limits are designed to provide reasonable protection against harmful interference in a residential installation. This equipment generates, uses and can radiate radio frequency energy and, if not installed and used in accordance with the instructions, may cause harmful interference to radio communications.

However, there is no guarantee that interference will not occur in a particular installation. If this equipment does cause harmful interference to radio or television reception, which can be determined by turning the equipment off and on, the user is encouraged to try to correct the interference by one or more of the following measures:

- Reorient or relocate the receiving antenna.
- Increase the separation between the equipment and receiver.
- Connect the equipment into an outlet on a circuit different from that to which the receiver is connected.
- Consult the dealer or an experienced radio/TV technician for help.

This Class B digital apparatus complies with Canadian ICES-003.

Cet appareil numérique de la classe B est conforme à la norme NMB-003 du Canada

LIMITED 1 YEAR WARRANTY

iHome Products, a division of SDI Technologies Inc. (hereafter referred to as SDI), warrants this product to be free from defects in workmanship and materials, under normal use and conditions, for a period of one (1) year from the date of original purchase.

Should this product fail to function in a satisfactory manner, it is best to first return it to the store where it was originally purchased. Should this fail to resolve the matter and service still be required by reason of any defect or malfunction during the warranty period, SDI will repair or, at its discretion, replace this product without charge. This decision is subject to verification of the defect or malfunction upon delivery of this product to the Factory Service Center authorized by SDI Customer Service. The product must include proof of purchase, including date of purchase. An out-of-warranty fee for service will be charged for units that are received without proof of purchase.

Before returning this product for service, please first replace the batteries (if applicable) with fresh ones, as exhausted or defective batteries are the most common cause of problems encountered. If service is still required:

1. Call SDI Customer Service at 1-877-446-6301 for Return Authorization and for the address of the Factory Service Center.
2. Remove the batteries (if applicable) and pack the unit in a well padded, heavy corrugated box. SDI is not responsible for damage that occurs during shipping to the Factory Service Center.
3. Enclose a photocopy of your sales receipt, credit card statement, or other proof of the date of purchase, if within the warranty period. Also include your name and address information, a brief description for why the unit is being returned, and the return authorization number. No unit can be processed without a return authorization number.
4. Write the return authorization number on the side of the shipping package and send the unit prepaid and insured to the Factory Service Center address authorized by SDI Customer Service.

Disclaimer of Warranty

NOTE: This warranty is valid only if the product is used for the purpose for which it was designed. It does not cover (i) products which have been damaged by negligence or willful actions, misuse or accident, or which have been modified or repaired by unauthorized persons; (ii) cracked or broken cabinets, or units damaged by excessive heat; (iii) damage to digital media players, CD's or tape cassettes (if applicable); (iv) the cost of shipping this product to the Factory Service Center and its return to the owner.

This warranty is valid only in the United States of America and does not extend to owners of the product other than to the original purchaser. In no event will SDI or any of its affiliates, contractors, resellers, their officers, directors, shareholders, members or agents be liable to you or any third party for any consequential or incidental damages, any lost profits, actual, exemplary or punitive damages. (Some states do not allow limitations on implied warranties or exclusion of consequential damages, so these restrictions may not apply to you.) This warranty gives you specific legal rights, and you may also have other rights which vary from state to state.

Your acknowledgement and agreement to fully and completely abide by the above mentioned disclaimer of warranty is contractually binding to you upon your transfer of currency (money order, cashier's check, or credit card) for purchase of your SDI product.

Questions? Visit www.ihomeaudio.com Toll Free Customer Service: 1-877-446-6301

©SDI Technologies 2013 All rights Reserved