

iHome

zenergy

WHITE NOISE



Model iZ2

Portable Sleep Therapy Machine

QUESTIONS? visit www.ihome.com

WELCOME

Thank you for choosing the iZ2 Zenergy White Noise Portable Sleep Therapy Machine from iHome. This user guide will get you up and running quickly. For more information about this and other iHome products, please visit www.ihome.com

GETTING STARTED

This unit ships with the following items. Please check to see that all items are present.

1. iZ2 speaker
2. 100-240V Universal AC power adapter
3. Aux-in audio cable

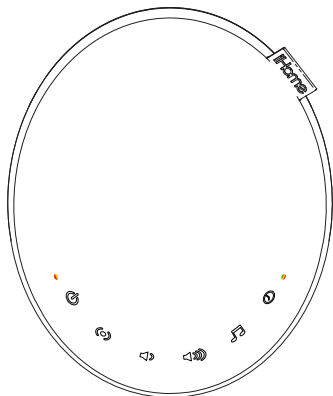

1. iZ2 speaker



2. AC adapter

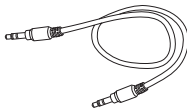

3. Aux-in cable

CONNECTING THE IZ2

Plug the included AC adapter into the DC jack on the back of the unit and connect the plug to a working outlet not controlled by a light switch.

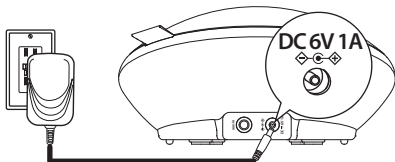

INSTALLING/REPLACING BATTERIES FOR PORTABLE USE

This unit requires 4 AA batteries (not included) for portable operation. We recommend alkaline batteries for longest life.

1. Use a Phillips screwdriver to unscrew battery compartment door on bottom of unit. Remove battery door.
2. Insert 4 new AA batteries, making sure to match polarity (+/-) as shown.
3. Replace battery door and tighten screw. Do not over-tighten.

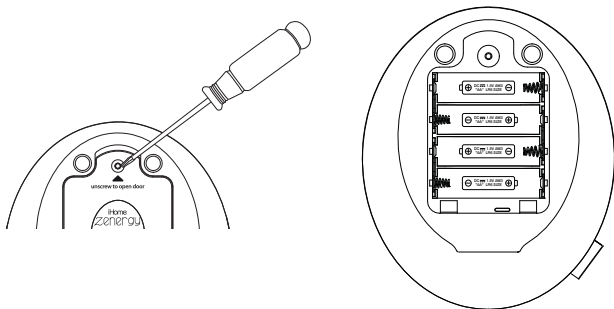

FEATURES & FUNCTIONS

TOP PANEL

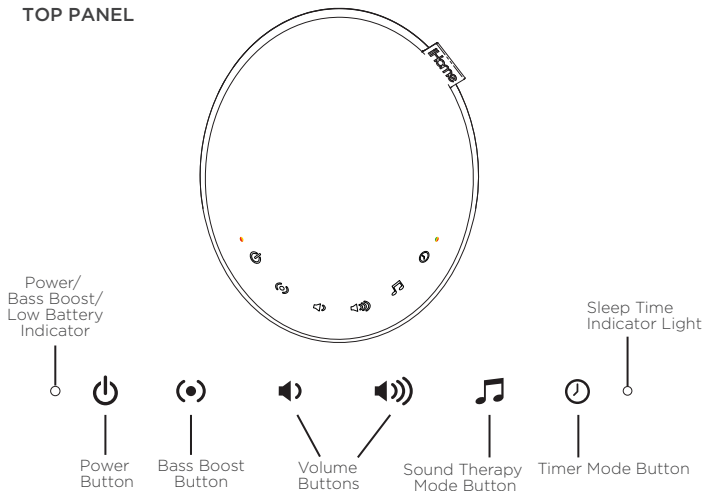

BACK PANEL

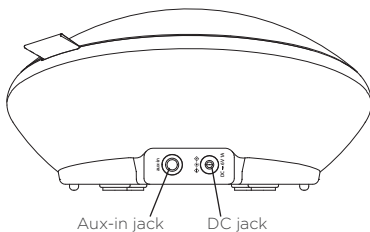

LOW BATTERY INDICATOR

- While operating on batteries, the LED low battery indicator will slowly blink red when batteries are low and need to be replaced.

TURNING THE UNIT ON AND OFF

- Press and release the **Power Button** to turn the unit ON or OFF.

SOUND THERAPY MODE



Distracting noises or a racing mind can make it hard to sleep at night or focus during the day. Sound Therapy uses specially recorded and engineered sounds to cancel out these distractions and allow your mind to calm.

1. Press the  **Sound Therapy Button** to access Sound Therapy mode.
Continue to press to cycle to each mode:

4-7-8 Breathing Guide: See next page for details

Calming Meditation: See Calming Breathing next page for details

- Zen:** A tonal melody in frequencies that mimic the Delta brainwaves of a mind in meditation or healing sleep
- Dream:** A tonal melody in frequencies that mimic the Theta brainwaves of a mind dreaming in REM sleep
- Ocean:** Authentic, digitally recorded ocean sounds
- Storm:** Authentic, digitally recorded storm and rainfall sounds
- Nature:** Authentic, digitally recorded springtime woodland sounds
- Air:** Brown noise is a low-toned repeating frequency, like a fan, which helps to negate distracting environmental noises
- Focus:** Pink noise is a medium-toned repeating frequency, like a soothing waterfall, which helps to negate distracting environmental noises
- Quiet:** The standard white noise repeating frequency, like radio static, which helps to actively negate distracting environmental noises
- Peace:** White noise and Delta tone melodies layered together help to quiet a noisy environment and an over-active mind
- Heartbeat:** Listening to a relaxed heart beat encourages your own heart

2. Press and release the   **Volume Buttons** to adjust speaker volume.
3. Press and hold the **Sound Therapy Button** for 2 seconds to exit sound therapy mode. Press the Sound Therapy Button again to resume at the last used sound preset.

MEDITATION & BREATHING

Research has shown that active breathing can calm the nervous system thereby reducing your heart rate and activating the parasympathic (calming) nervous system to improve memory, positively impact emotional behaviors to help cope with stress, anxiety and make it easier to fall asleep.



4-7-8 BREATHING GUIDE

4-7-8 breathing meditation features a soothing voiced guide that fades and synchronizes with pulsing lighting effects to control your breath, lower your heart rate and soothe the body and mind.

- 4 sec** Breathe in through your nose, filling the belly.
- 7 sec** Hold breath.
- 8 sec** Slowly exhale through your mouth.
Repeat.





CALMING BREATHING

Frequencies mimicking the delta brainwaves along with a calming breathing sound effect can help coax our minds into a deep meditative state. This is a great alternative and easier exercise to the 4-7-8 method.

- 5 sec** Breathe in slowly through your nose.
- 5 sec** Exhale slowly through your mouth.
Repeat.

TIMER MODE

The programmable timer mode lets you set sound therapy to play for a set duration. The sound levels will gradually decrease over the last 15 minutes (fade begins right away if timer is set to 10 minutes or less) until the unit shuts off.

Press and release the  **Timer Button** as needed to cycle to the desired timer duration: 90, 60, 30, 20, 10, 5, 2 minutes or OFF. Timer mode is first indicated by a voice guide and the timer indicator light next to the Timer button. Green indicates more than 1 hour remaining, yellow indicates 11-60 minutes remaining, and red indicates 10 minutes or less remaining. Timer mode is inactive when no timer indicator is lit. *Press and hold* the  **Timer Button** to cancel timer mode.

AUX-IN AUDIO MODE

Connect the included aux-in audio cable to the headphone or other audio output jack on your audio device and the other end to the aux-in jack located on the back of the Sleep Therapy Machine. The unit will auto-detect the the aux connector once it is plugged in. Aux audio will override other tones while cable is connected.

- Power on the Sleep Therapy Machine
- Select and control audio on your device
- Adjust volume output on your device. Press the **Volume Buttons** to adjust speaker volume.

BASS BOOST MODE

If more bass is desired in Sound Therapy or Aux-in audio mode, press and release the  **Bass Boost Button** as needed to toggle bass boost ON or OFF (ON is indicated by LED to left of controls flashing green three times, and OFF by flashing red three times).

MAINTENANCE

- Place the unit on a level surface away from sources of direct sunlight or excessive heat.
- Protect your furniture when placing your unit on a natural wood and lacquered finish. A cloth or other protective material should be placed between it and the furniture.
- Clean your unit with a soft cloth moistened only with mild soap and water. Stronger cleaning agents such as thinner or similar materials can damage the surface of the unit.

This product is not a medical device and is not intended to diagnose, treat, cure, or prevent any disease.

Battery Cautions and Tips

- Only use the recommended/supplied batteries or equivalent.
- Use alkaline batteries for longer life.
- Do not mix old and new batteries, and do not mix alkaline, carbon-zinc or rechargeable nickel-cadmium batteries.
- Insert batteries with proper polarity (+/-) as indicated.
- Remove exhausted batteries from product.
- Do not attempt to recharge non-rechargeable batteries.
- Do not open batteries or heat them beyond normal ambient temperatures.
- To prevent battery leakage or damage remove batteries from a product if it will not be used for a month or longer.
- Use extreme caution handling leaking batteries (avoid direct contact with eyes and skin). If battery leakage comes in contact with eyes, IMMEDIATELY flush the eye with lukewarm and gently flowing water for at least 30 minutes. If skin contact occurs, wash skin with clear water for at least 15 minutes. Seek medical attention if any symptoms occur.
- Store in cool, dry, ventilated area away from hazardous or combustible material.
- Do not dispose of batteries in the household trash or fire.
- Follow applicable laws and local regulations for the disposal and transportation of batteries.

FCC Information

FCC Radiation Exposure Statement

This equipment complies with FCC radiation exposure limits set forth for an uncontrolled environment.

This device complies with Part 15 of the FCC Rules, operation is subject to the following two conditions: (1) This device may not cause harmful interference, and (2) this device must accept any interference received, including interference that may cause undesired operation.

- **Warning:** Changes or modifications to this unit not expressly approved by the party responsible for compliance could void the user's authority to operate the equipment.
- **NOTE:** This equipment has been tested and found to comply with the limits for a Class B digital device, pursuant to Part 15 of the FCC Rules.

These limits are designed to provide reasonable protection against harmful interference in a residential installation. This equipment generates, uses and can radiate radio frequency energy and, if not installed and used in accordance with the instructions, may cause harmful interference to radio communications.

However, there is no guarantee that interference will not occur in a particular installation. If this equipment does cause harmful interference to radio or television reception, which can be determined by turning the equipment off and on, the user is encouraged to try to correct the interference by one or more of the following measures:

- Reorient or relocate the receiving antenna.
- Increase the separation between the equipment and receiver.
- Connect the equipment into an outlet on a circuit different from that to which the receiver is connected.
- Consult the dealer or an experienced radio/TV technician for help.

CAN ICES-3 (B)/NMB-3(B)

IMPORTANT SAFETY TIPS

When used in the directed manner, this unit has been designed and manufactured to ensure your personal safety. However, improper use can result in potential electrical shock or fire hazards. Please read all safety and operating instructions carefully before installation and use, and keep these instructions handy for future reference. Take special note of all warnings listed in these instructions and on the unit.

1. **Water and Moisture** - The unit should not be used near water. For example: near a bathtub, washbowl, kitchen sink, laundry tub, swimming pool or in a wet basement.
2. **Ventilation** - The unit should be situated so that its location or position does not interfere with its proper ventilation. For example, it should not be situated on a bed, sofa, rug or similar surface that may block ventilation openings. Also, it should not be placed in a built-in installation, such as a bookcase or cabinet, which may impede the flow of air through the ventilation openings.
3. **Heat** - The unit should be situated away from heat sources such as radiators, heat registers, stoves or other appliances (including amplifiers) that produce heat.
4. **Power Sources** - The unit should be connected to a power supply only of the type described in the operating instructions or as marked on the appliance. Only use the AC adapter that came with the unit.
5. **Power-Cable Protection** - Power supply cables should be routed so that they are not likely to be walked on or pinched by items placed upon or against them. It is always best to have a clear area from where the cable exits the unit to where it is plugged into an AC socket.
6. **Cleaning** - The unit should be cleaned only as recommended. See the Maintenance section of this manual for cleaning instructions.
7. **Objects and Liquid Entry** - Care should be taken so that objects do not fall and liquids are not spilled into any openings or vents located on the product.
8. **Attachments** - Do not use attachments not recommended by the product manufacturer.
9. **Lightning and Power Surge Protection** - Unplug the unit from the wall socket and disconnect the antenna or cable system during a lightning storm or when it is left unattended and unused for long periods of time. This will prevent damage to the product due to lightning and power-line surges.
10. **Overloading** - Do not overload wall sockets, extension cords, or integral convenience receptacles as this can result in a risk of fire or electric shock.
11. **Damage Requiring Service** - The unit should be serviced by qualified service personnel when:
 - A. the power supply cable or plug has been damaged.
 - B. objects have fallen into or liquid has been spilled into the enclosure.
 - C. the unit has been exposed to rain.
 - D. the unit has been dropped or the enclosure damaged.
 - E. the unit exhibits a marked change in performance or does not operate normally.
12. **Periods of Nonuse** - If the unit is to be left unused for an extended period of time, such as a month or longer, remove batteries before storage
13. **Servicing** - The user should not attempt to service the unit beyond those methods described in the user's operating instructions. Service methods not covered in the operating instructions should be referred to qualified service personnel.
14. **Magnetic Interference**: This product's speakers contain powerful magnets which could cause interference or damage to sensitive equipment such as hard drives, CRT televisions and monitors, as well as medical, scientific, and navigational devices. Keep this unit away from these products at all times.

© 2018 SDI Technologies, Inc. All rights reserved
Questions? Visit www.ihome.com
or call 1-800-288-2792 Toll Free